

TABLE OF CONTENTS:

- | | |
|---|---|
| <ul style="list-style-type: none"> 1) HORIZONTAL JOINT 1A) HORIZONTAL JOINT WITH INSULATION 1B) HORIZONTAL JOINT OPTIONS 2) VERTICAL JOINT 2A) VERTICAL JOINT WITH INSULATION 3) PANEL SILL 3A) PANEL SILL WITH INSULATION 4) PANEL JAMB 4A) PANEL JAMB WITH INSULATION 5) PANEL HEAD AND WINDOW SILL 5A) PANEL HEAD AT WINDOW SILL WITH INSULATION 5B) OFF-MODULE PANEL HEAD AT WINDOW SILL 6) PANEL SILL AT WINDOW HEAD 6A) PANEL SILL AT WINDOW HEAD WITH INSULATION | <ul style="list-style-type: none"> 7) PANEL JAMB AT WINDOW 7A) PANEL JAMB AT WINDOW WITH INSULATION 8) PANEL HEAD AT CURTAIN WALL SILL 8A) PANEL HEAD AT CURTAINWALL SILL WITH INSULATION 9) PANEL SILL AT CURTAIN WALL HEAD 9A) PANEL SILL AT CURTAIN WALL HEAD WITH INSULATION 10) PANEL JAMB AT CURTAINWALL 10A) PANEL JAMB AT CURTAINWALL WITH INSULATION 11) COPING DETAIL 11A) COPING DETAIL WITH INSULATION 11B) COPING OPTION 12) OUTSIDE CORNER DETAIL 12A) OUTSIDE CORNER DETAIL WITH INSULATION 12B) OPTIONAL OUTSIDE CORNER DETAILS 13) INSIDE CORNER 13A) INSIDE CORNER DETAIL WITH INSULATION |
|---|---|

GENERAL PANEL SYSTEM NOTES:

- ARCWALL INTERLOK PLANK PANEL SYSTEM IS A RAINSCREEN SYSTEM WHICH REQUIRES A BACKUP SUBSTRATE SYSTEM TO BE SEALED. THE SHEATHING AND AIR-VAPOR BARRIER SHOULD BE DESIGNED TO WITHSTAND THE SPECIFIED PERFORMANCE CRITERIA.
- ALL PENETRATIONS BY FASTENERS FOR THE PANEL SYSTEM THROUGH THE AIR/VAPOR BARRIER SHOULD BE SEALED AS RECOMMENDED BY THE SPECIFIED A/V BARRIER SUPPLIER SELECTED BY THE DESIGN PROFESSIONAL.
- ALL SYSTEM DETAILS SHOWN HERE SHOW TOP DOWN INSTALLATION. THIS PRODUCT CAN BE INSTALLED EITHER TOP/DOWN OR BOTTOM/UP. CONSULT SALES FOR RECOMMENDED METHOD FOR YOUR PROJECT.

ELEVATION JOINT OPTIONS

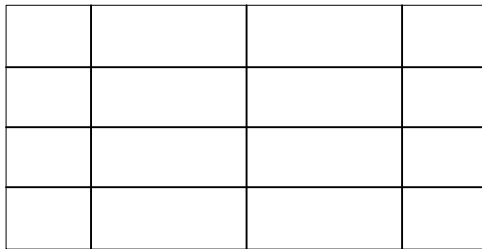

LINEAR JOINTS

OR

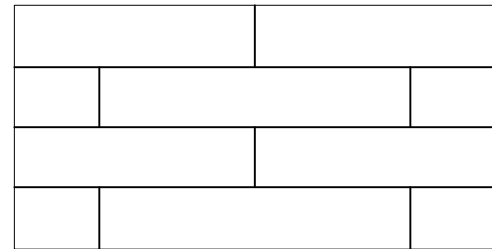

RUNNING BOND

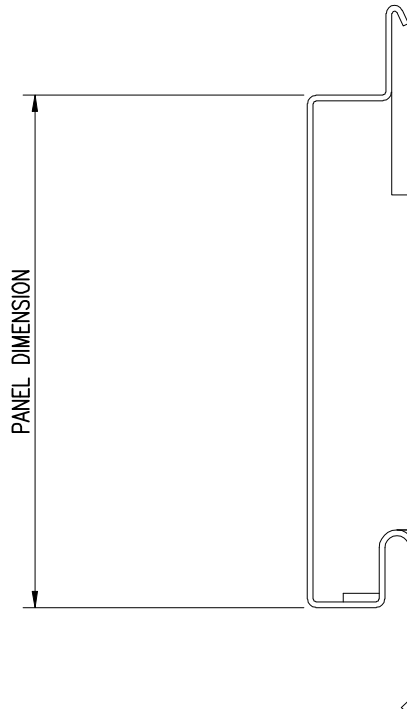

STANDARD PANEL PROFILE

- 1) PENETRATIONS IN AIR/VAPOR BARRIER TO BE COORDINATED WITH SEALS REQUIRED WITH SPECIFIED MATERIALS.
2) BOTTOM UP PANEL INSTALLATION OPTIONS AVAILABLE BASED ON MATERIALS SELECTED.

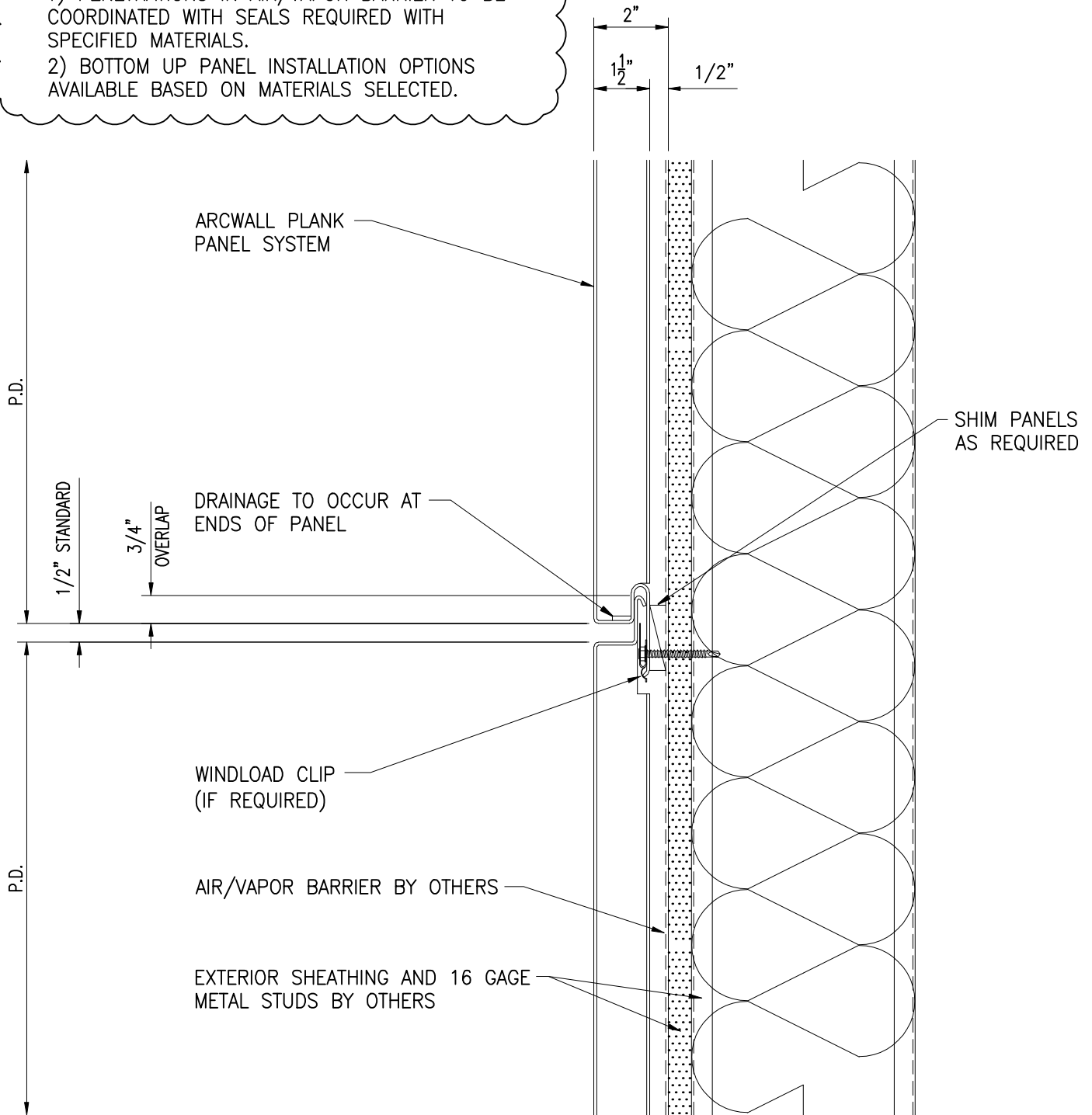

1) Horizontal Joint

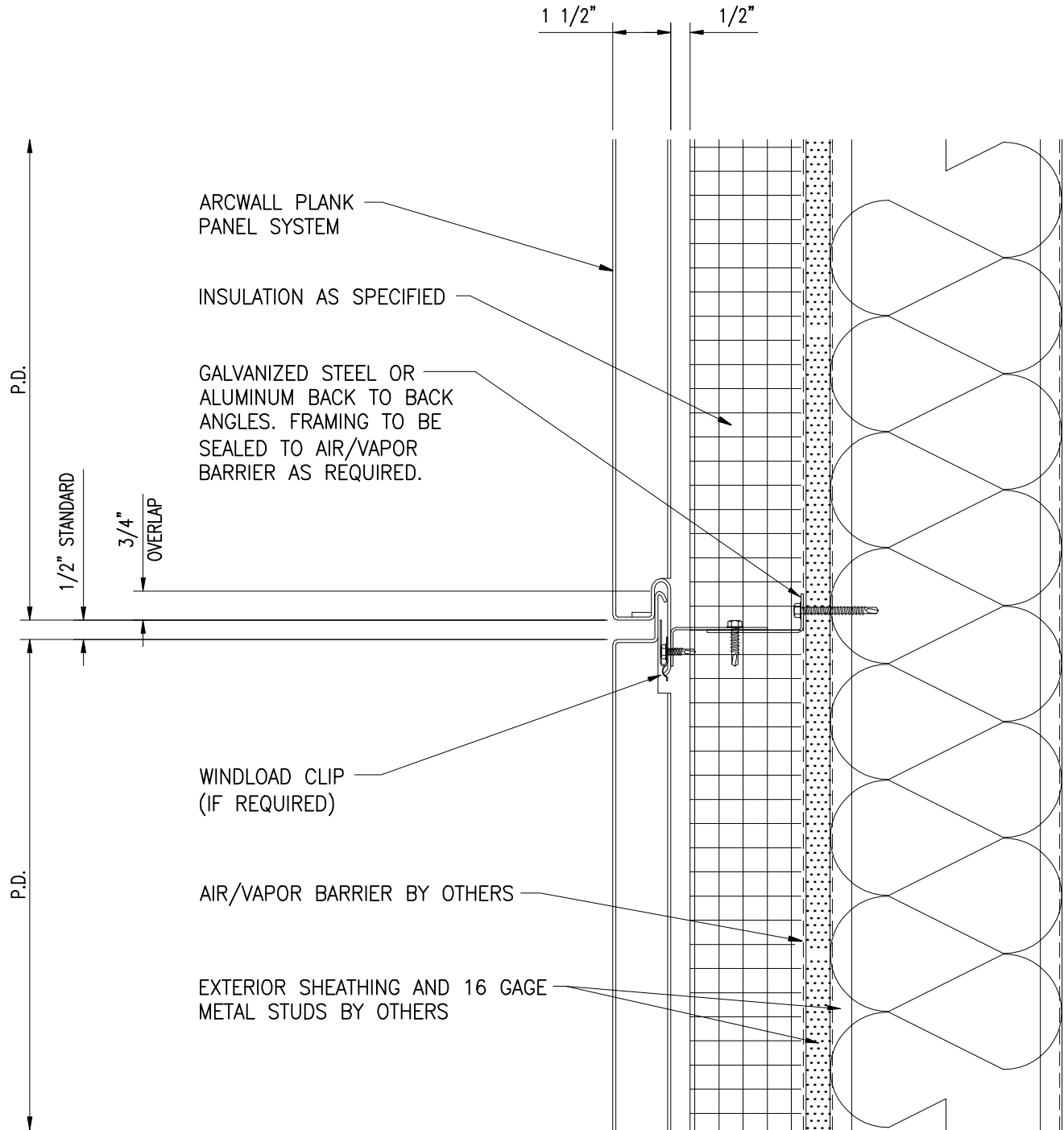

1A) Horizontal Joint With Insulation

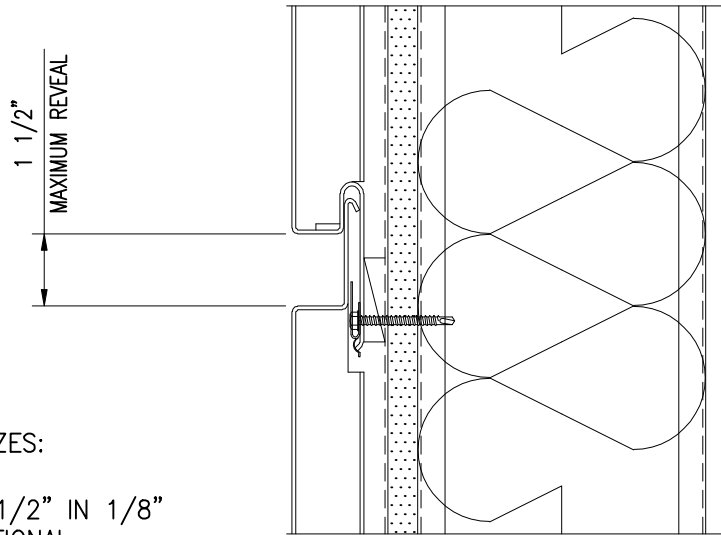

OPTIONAL REVEAL SIZES:

- 1/2" STANDARD.
- 1/8" UP TO 1 1/2" IN 1/8" INCREMENTS OPTIONAL

REVEAL SIZE OPTIONS

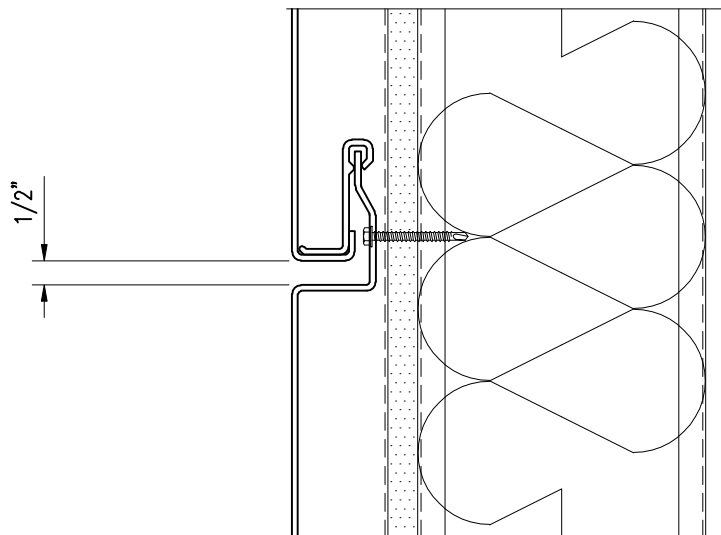

BOTTOM UP PANEL
INSTALLATION OPTION

1B) Horizontal Joint Options

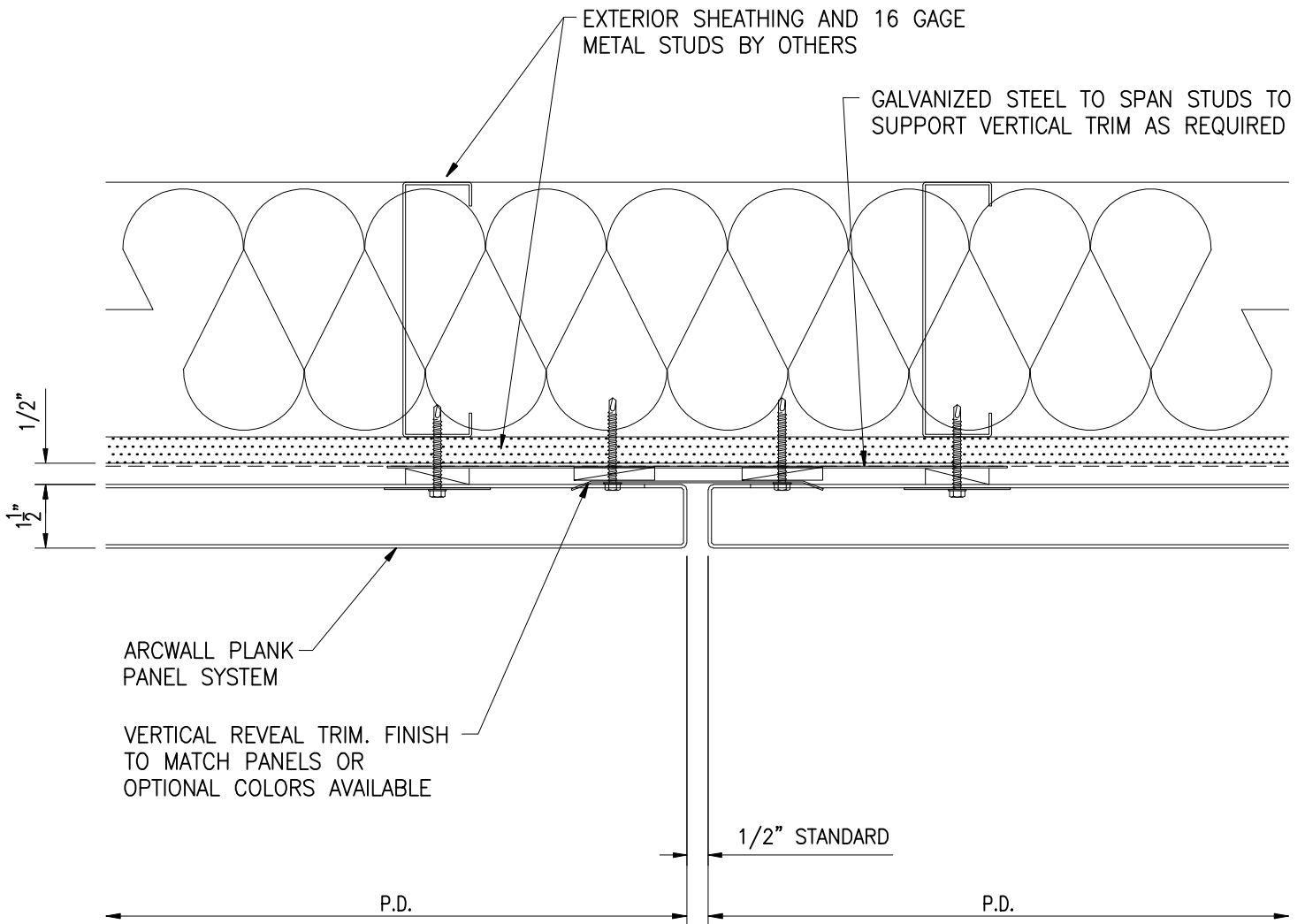

CONTACT METAL SALES AND SERVICE FOR REVEAL OPTIONS

2) Vertical Joint

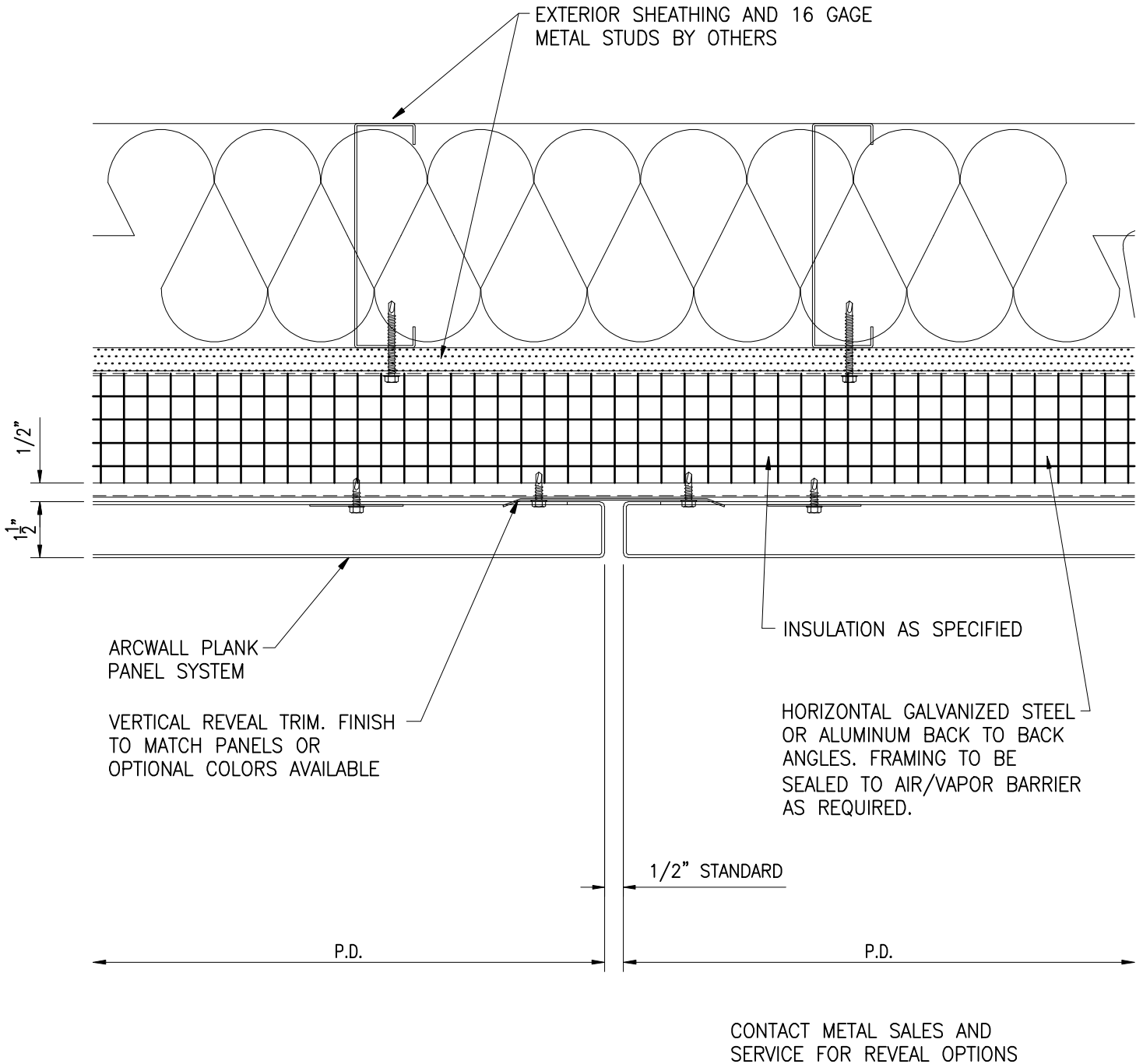

2A) Vertical Joint With Insulation

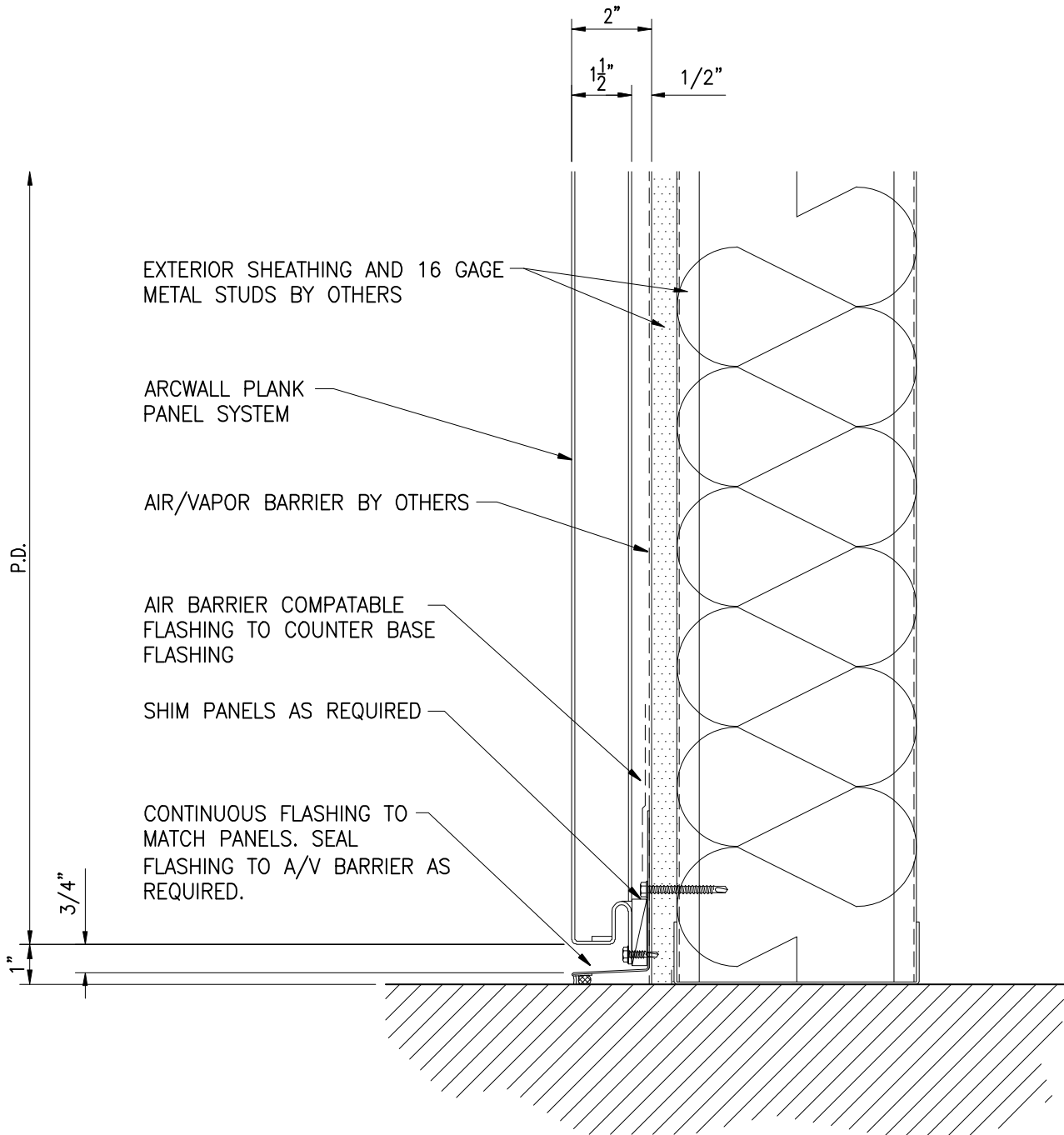

3) Panel Sill

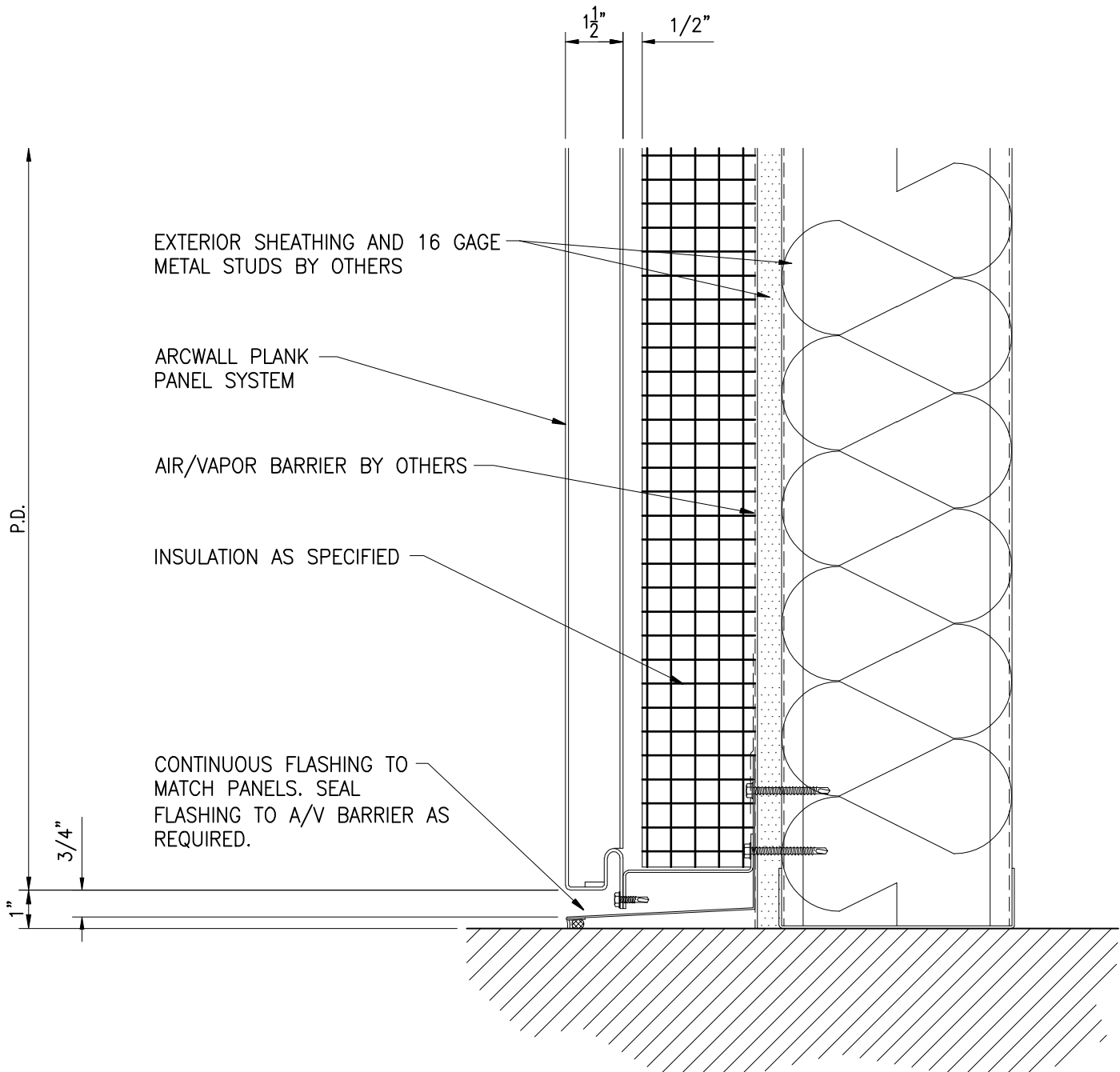

3A) Panel Sill With Insulation

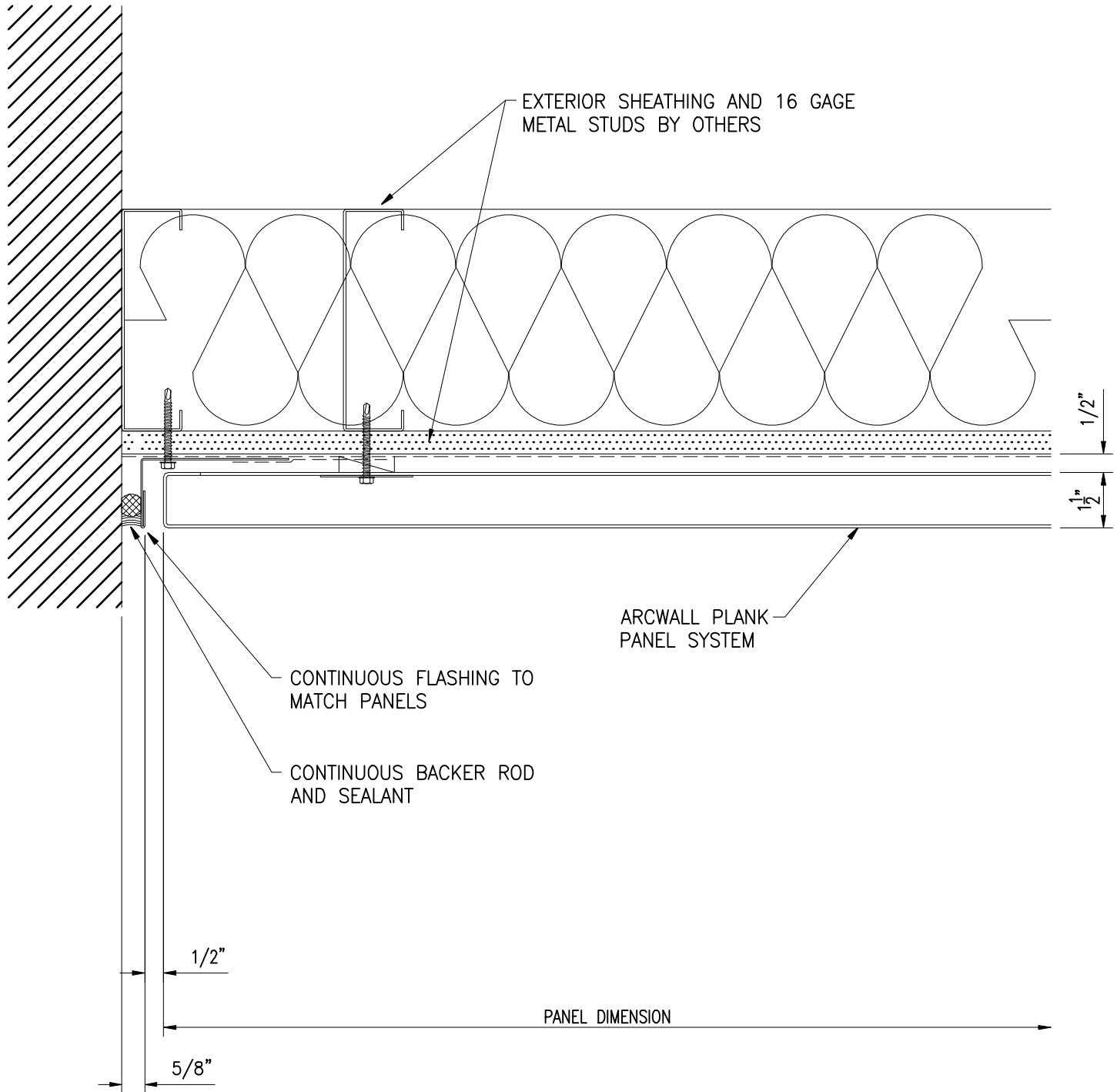

4) Panel Jamb

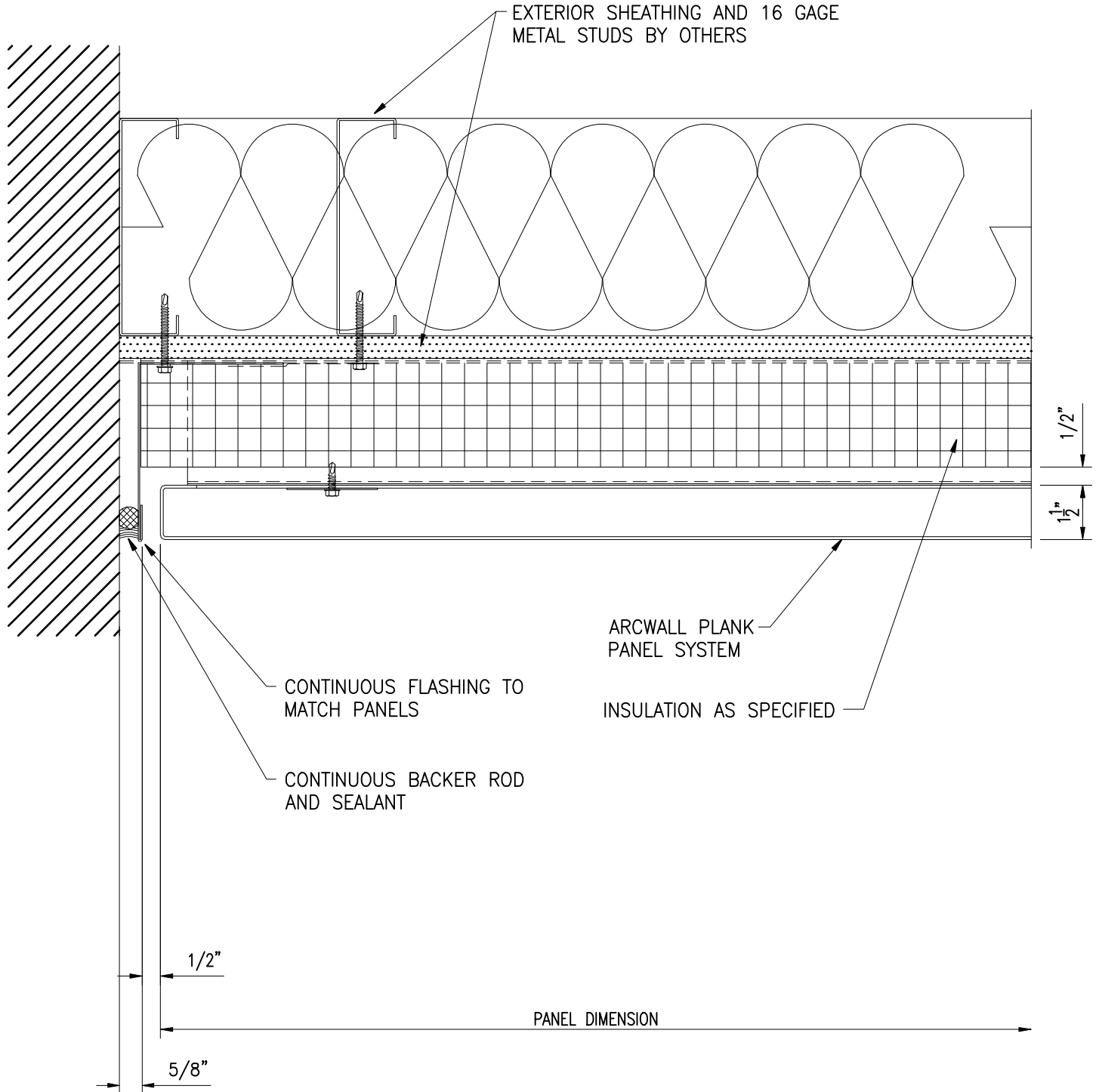

4A) Panel Jamb With Insulation

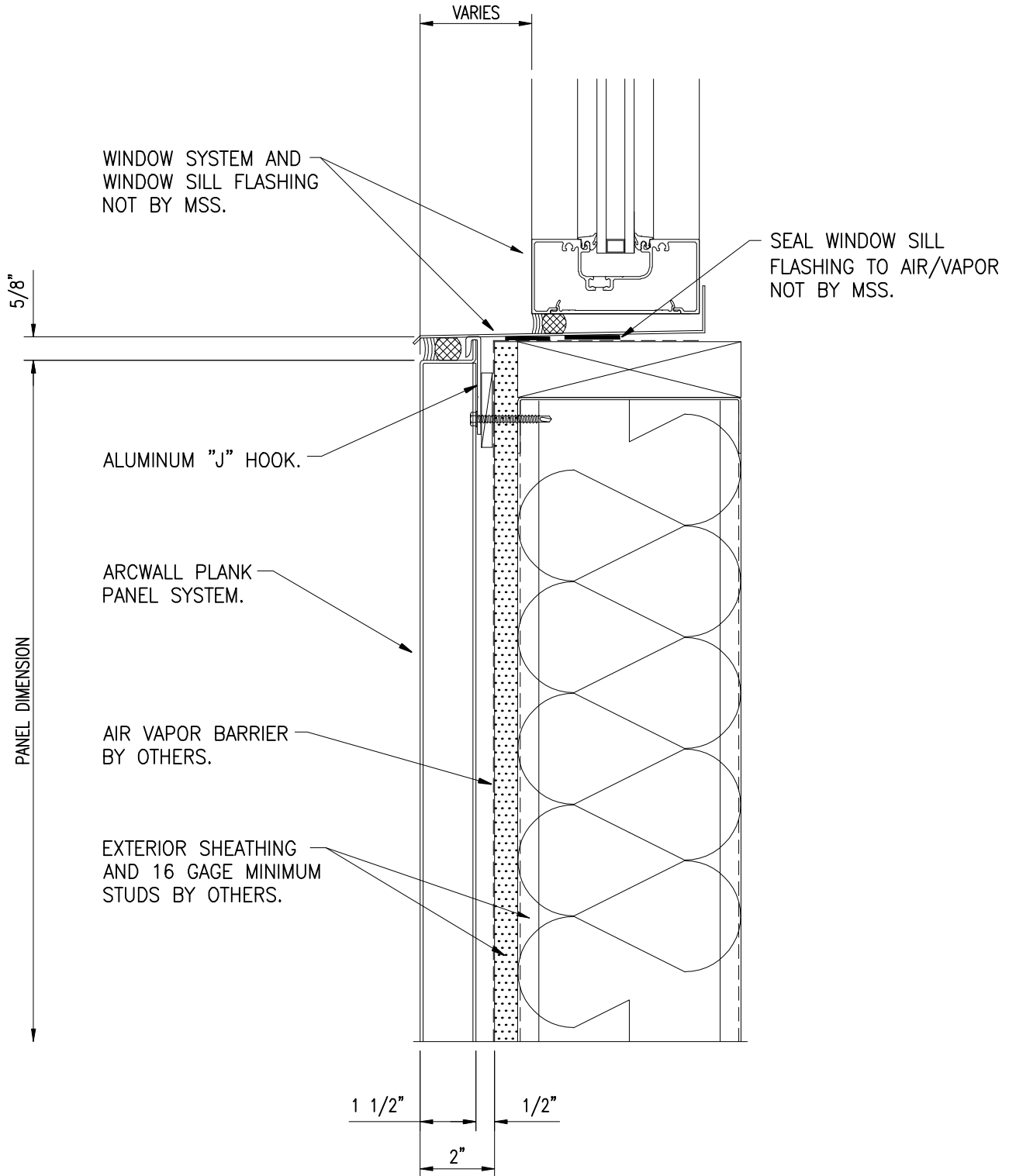

5) PANEL HEAD AT WINDOW SILL

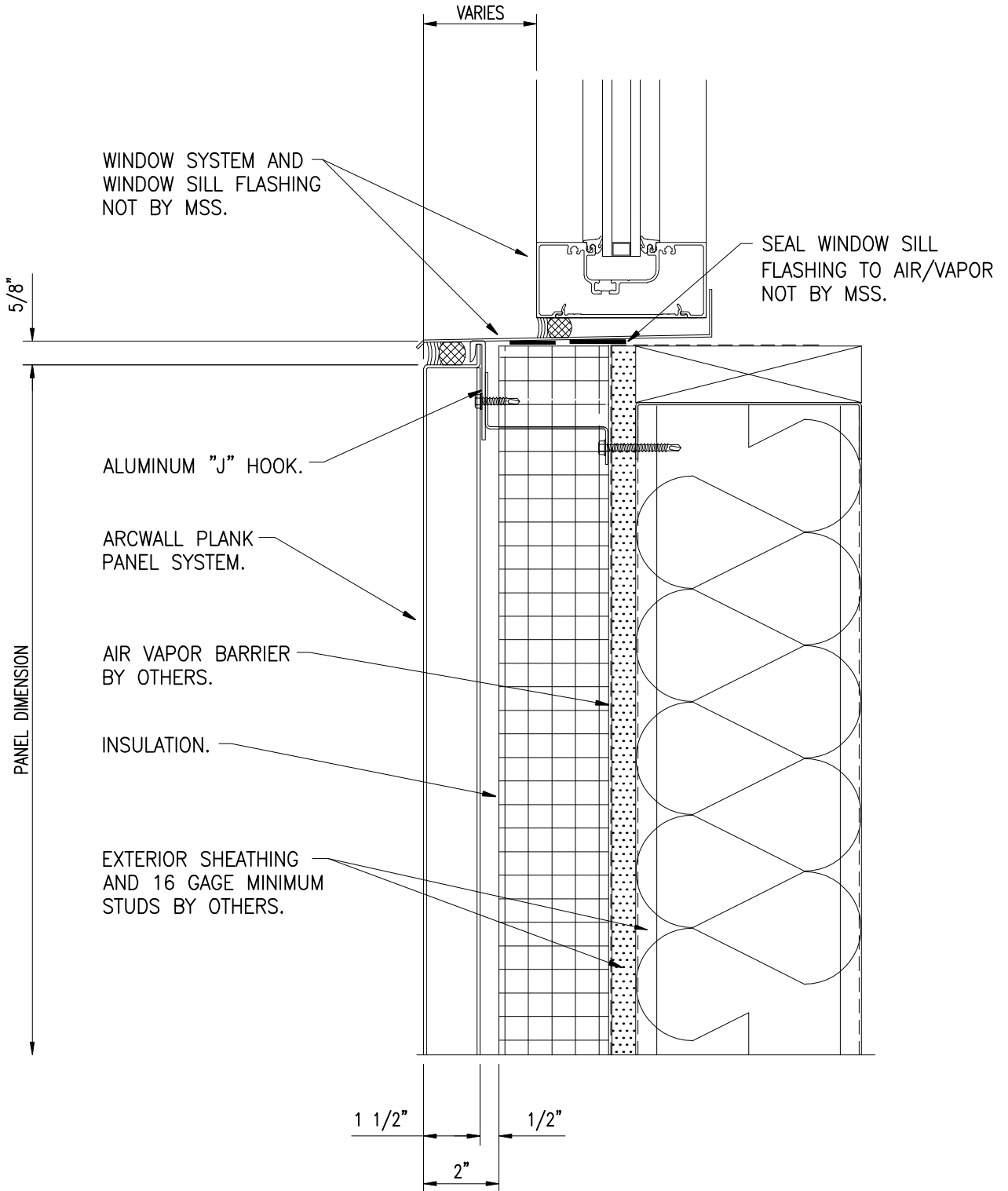

**5A) PANEL HEAD WITH INSULATION
AT WINDOW SILL**

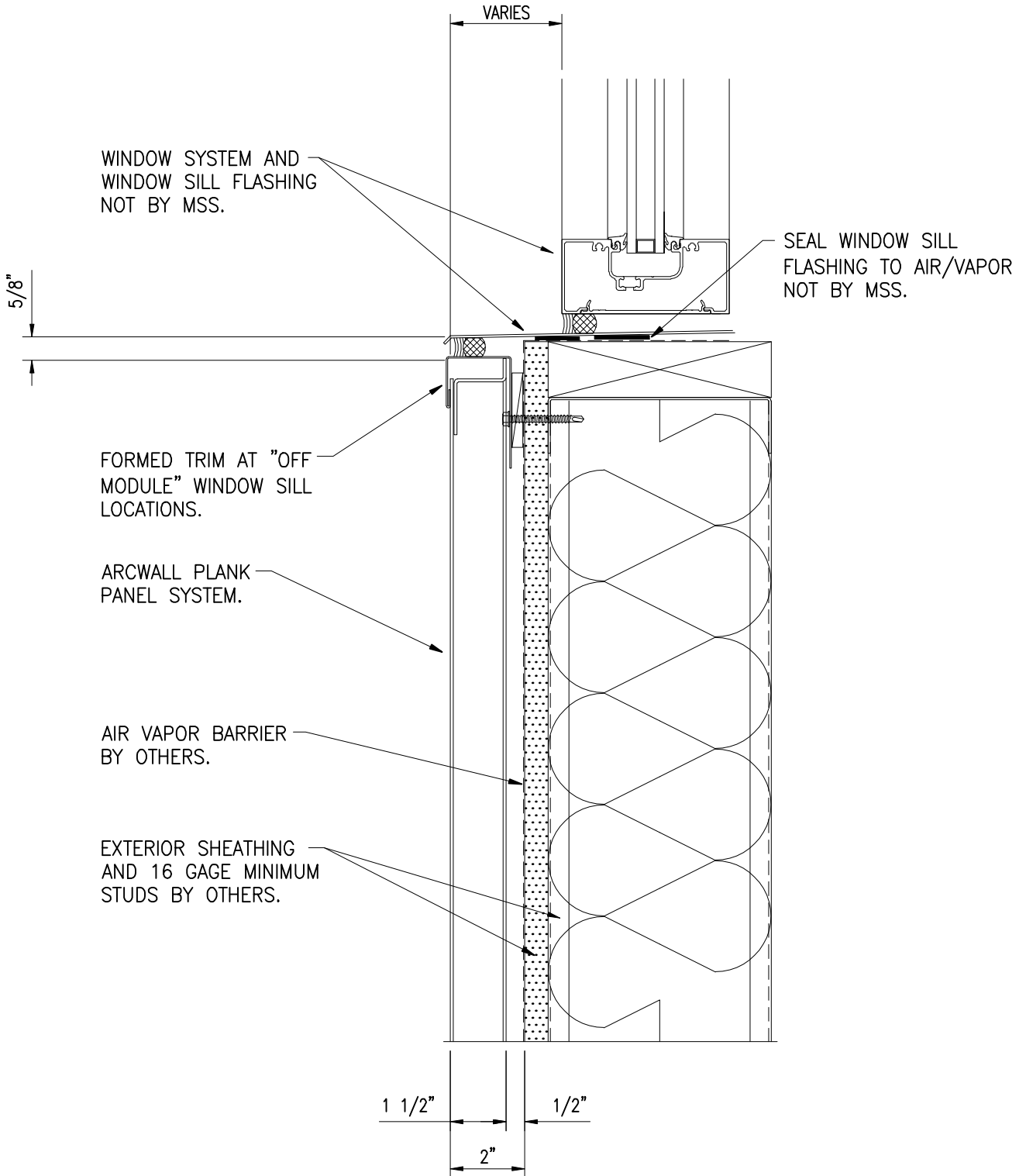

**5B) OFF-MODULE PANEL HEAD
AT WINDOW SILL**

ARCWALL INTERLOK PLANK
TYPICAL DETAILS
RAINSCREEN PANEL SYSTEM

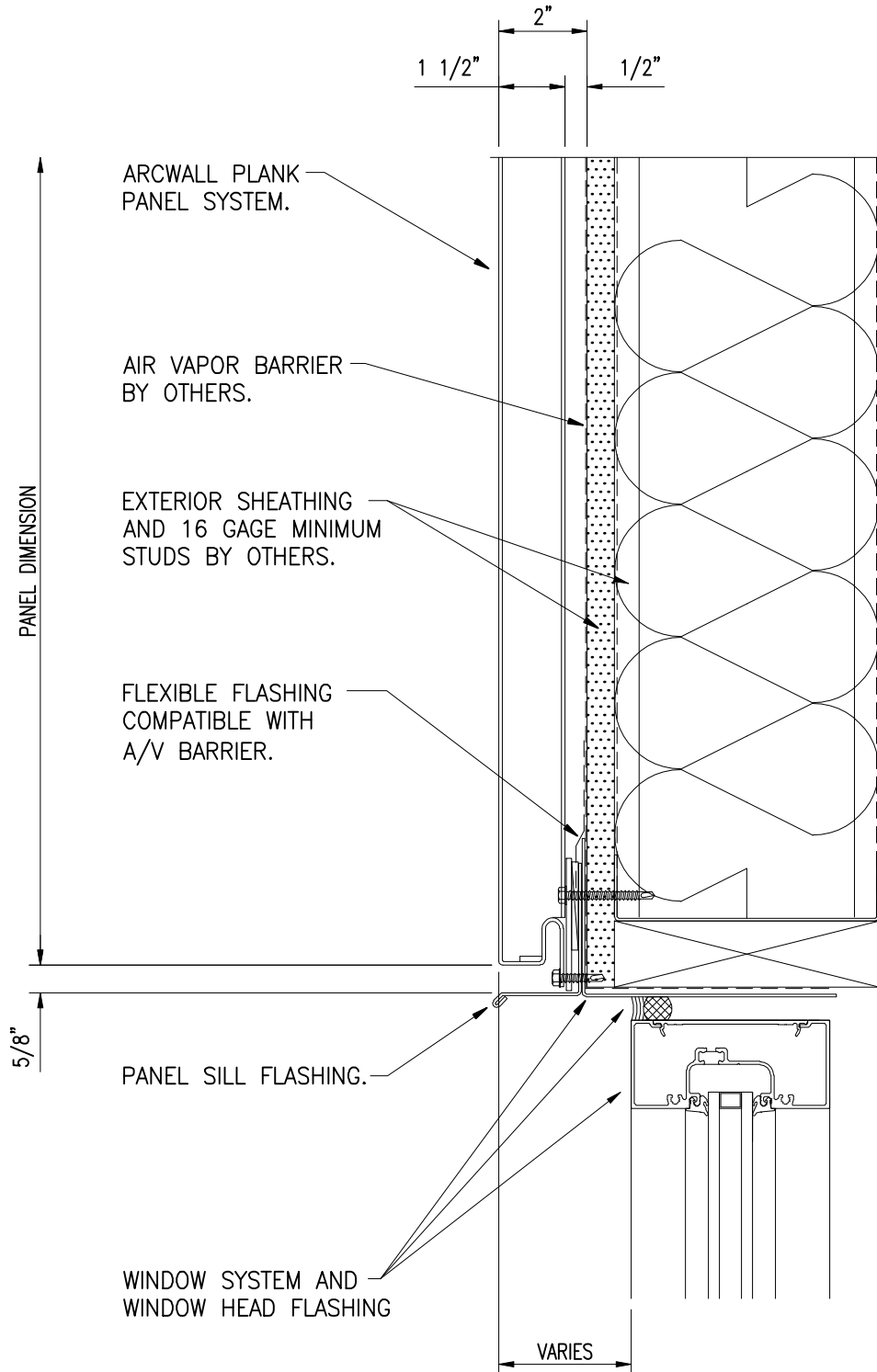

6) PANEL SILL AT WINDOW HEAD

ARCWALL INTERLOK PLANK
TYPICAL DETAILS
RAINSCREEN PANEL SYSTEM

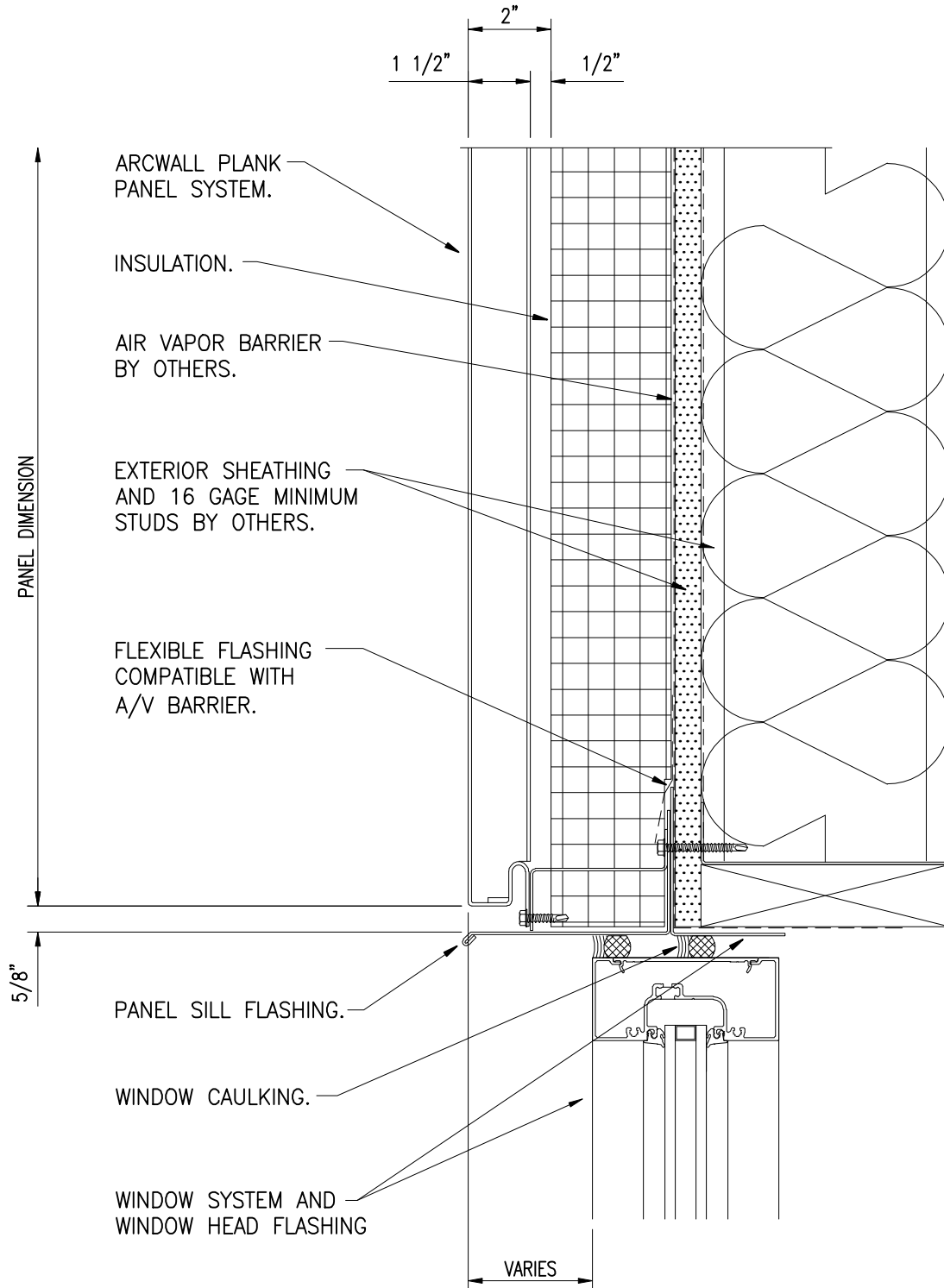

6A) PANEL SILL WITH INSULATION
AT WINDOW HEAD

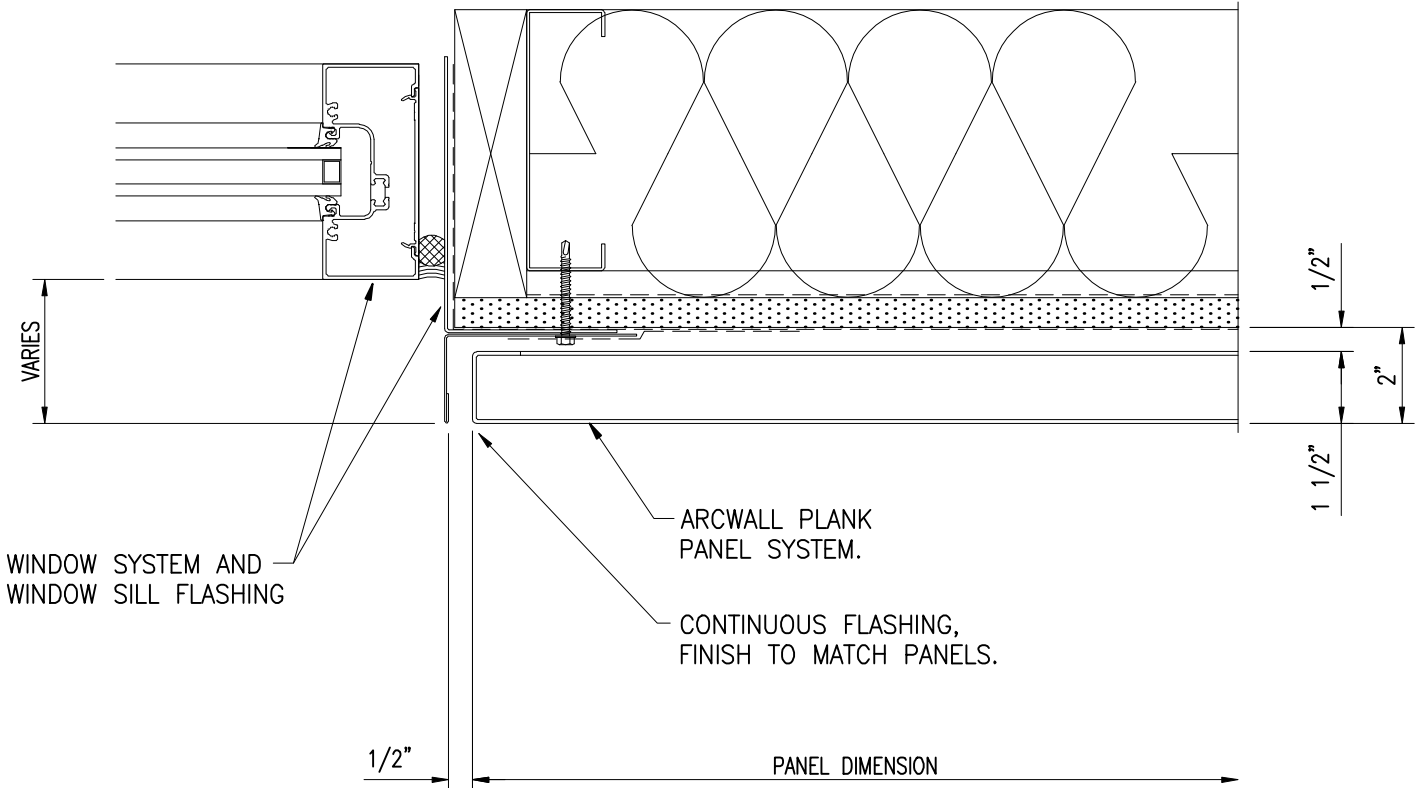

7) PANEL JAMB AT WINDOW

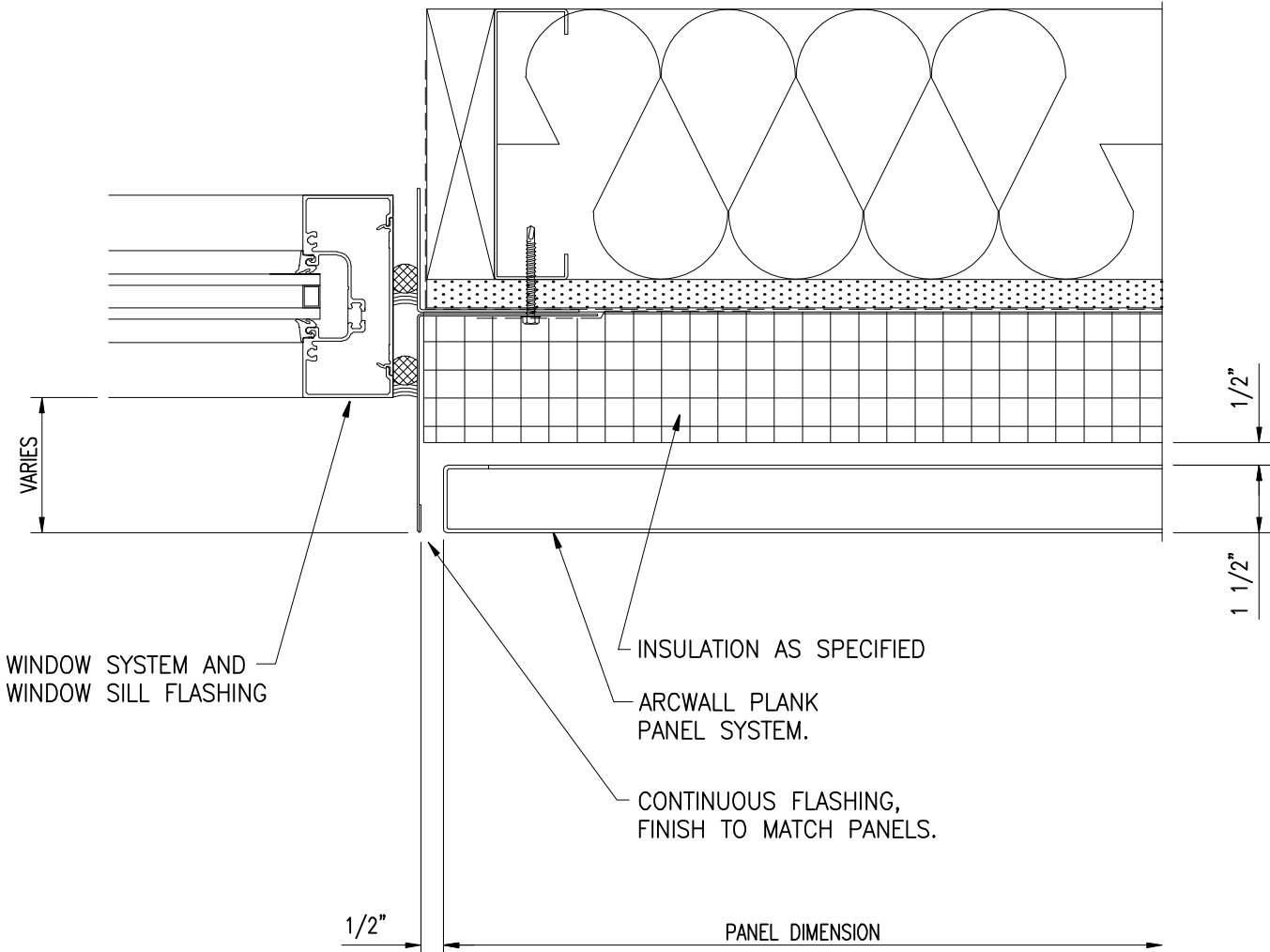

7A) PANEL JAMB WITH INSULATION AT WINDOW

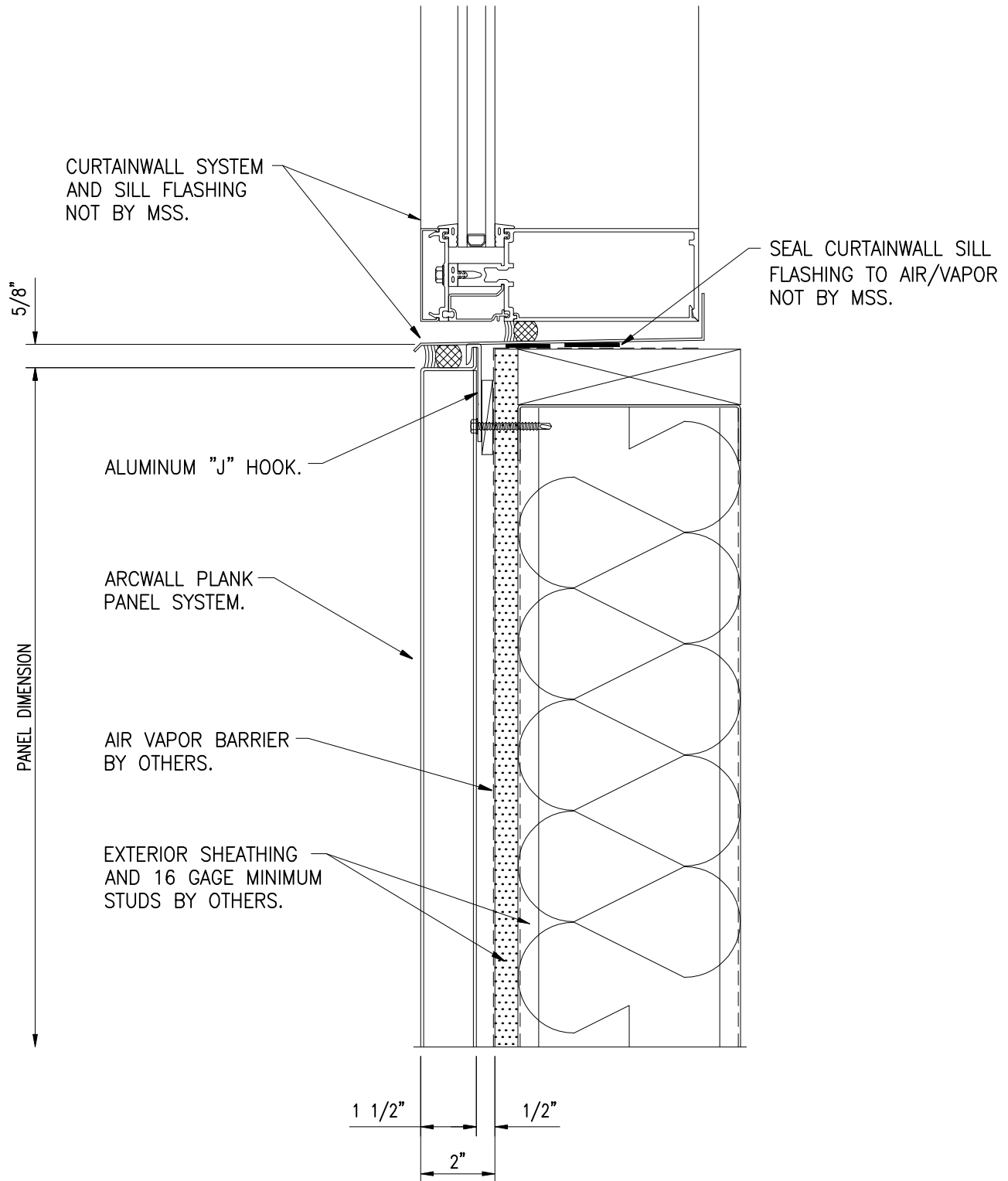

8) PANEL HEAD AT CURTAINWALL SILL

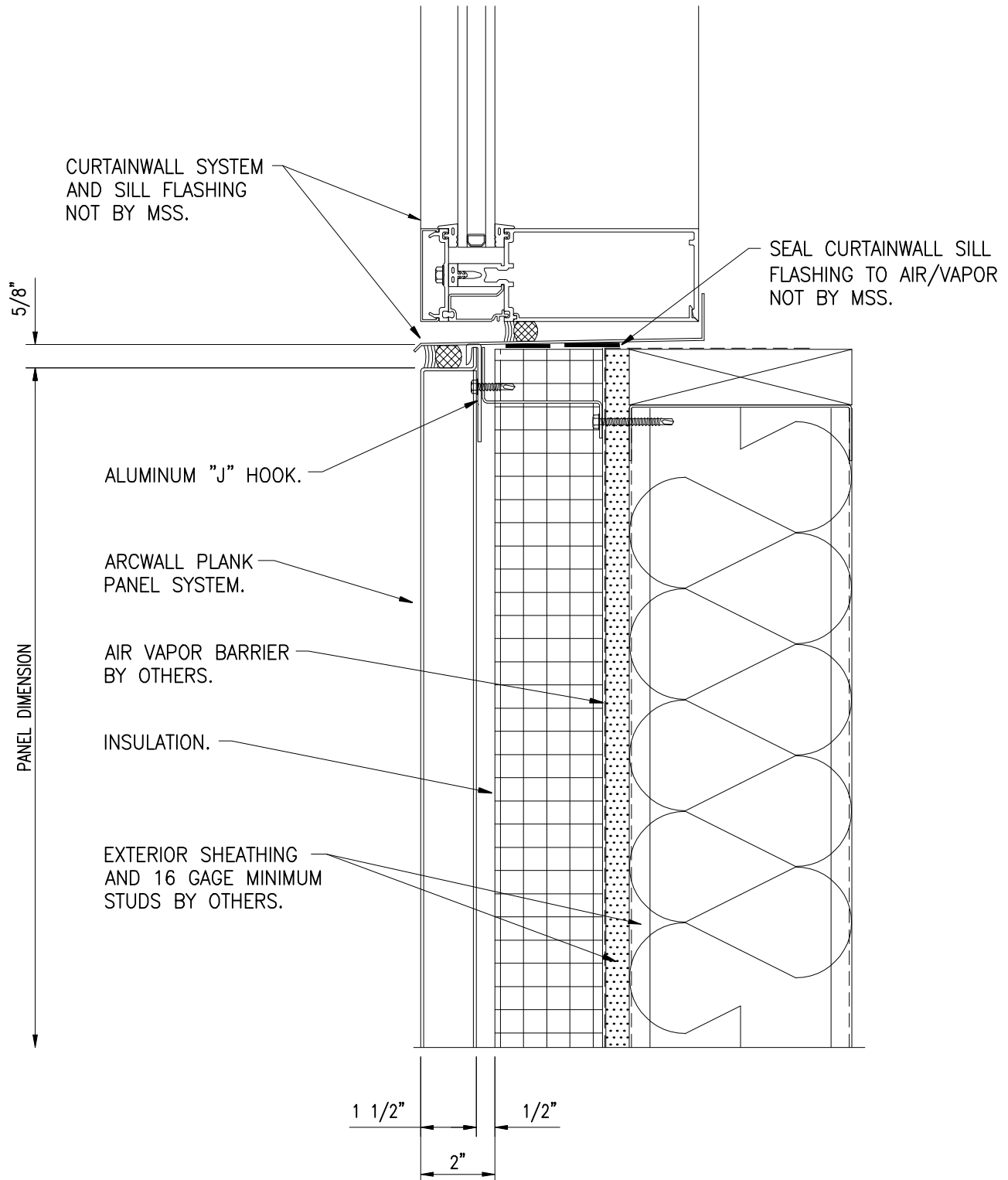

**8A) PANEL HEAD WITH INSULATION
AT CURTAINWALL SILL**

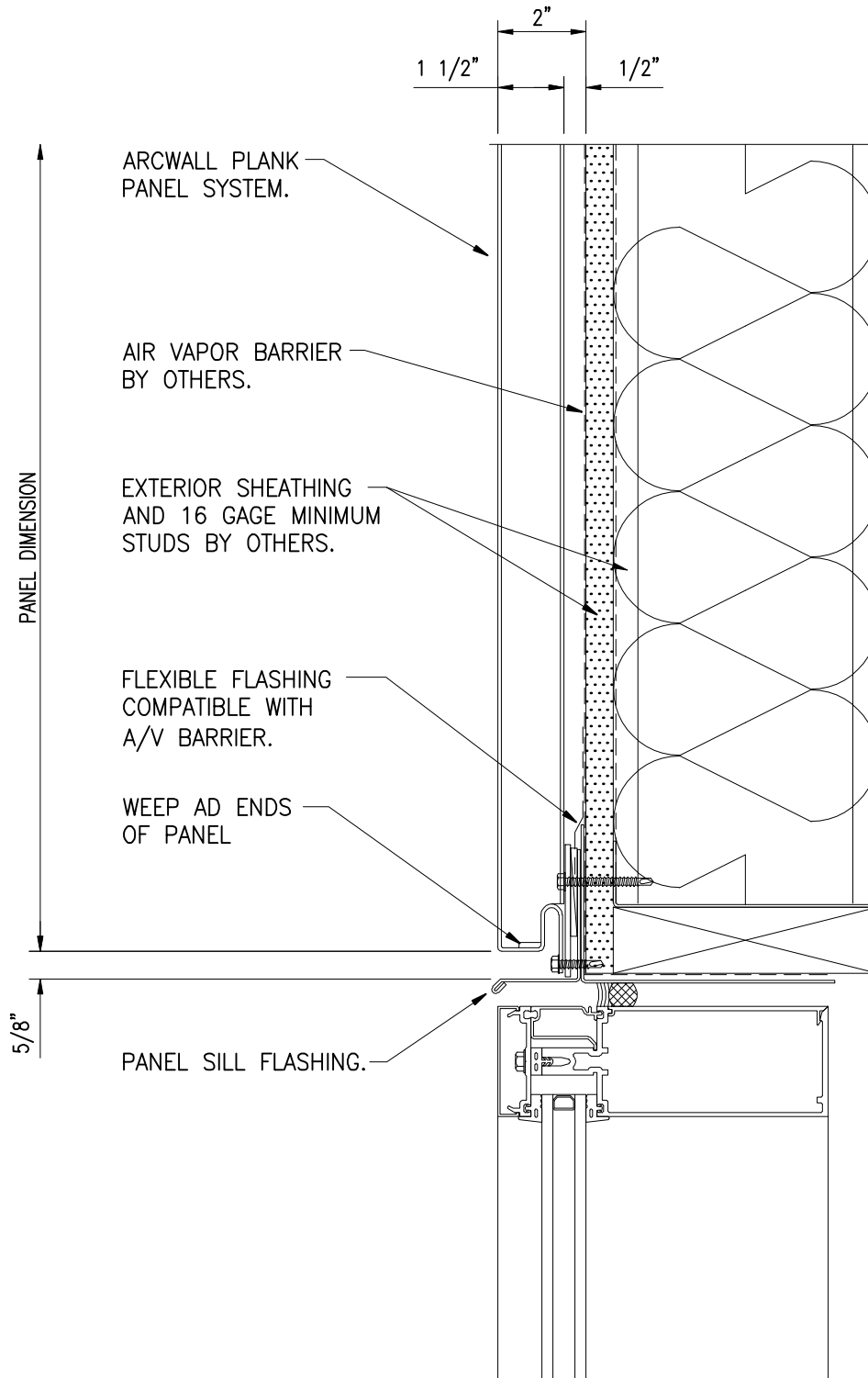

9) PANEL SILL AT CURTAINWALL HEAD

ARCWALL INTERLOK PLANK
TYPICAL DETAILS
RAINSCREEN PANEL SYSTEM

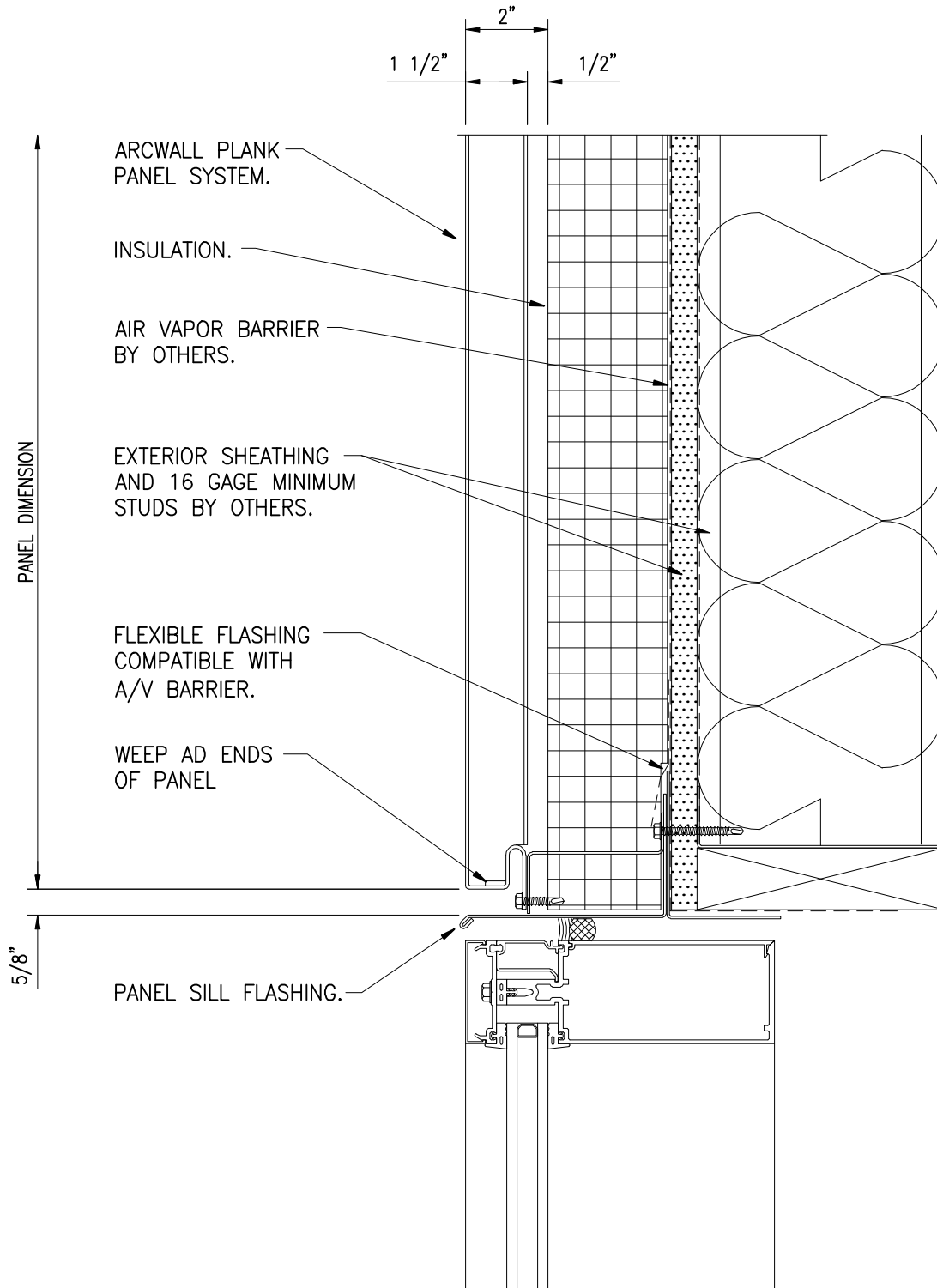

9A) PANEL SILL WITH INSULATION
AT CURTAINWALL HEAD

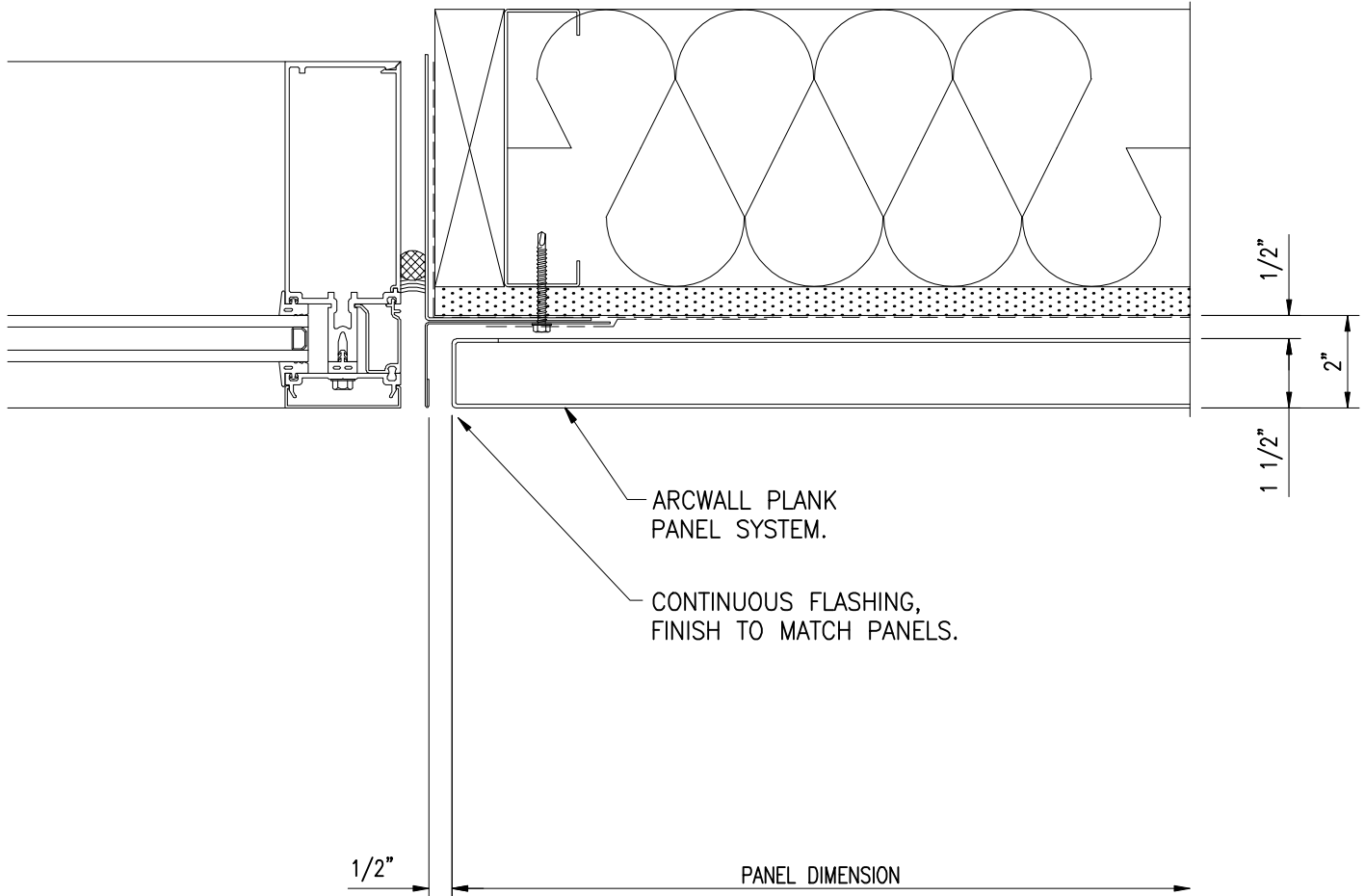

10) PANEL JAMB DETAIL

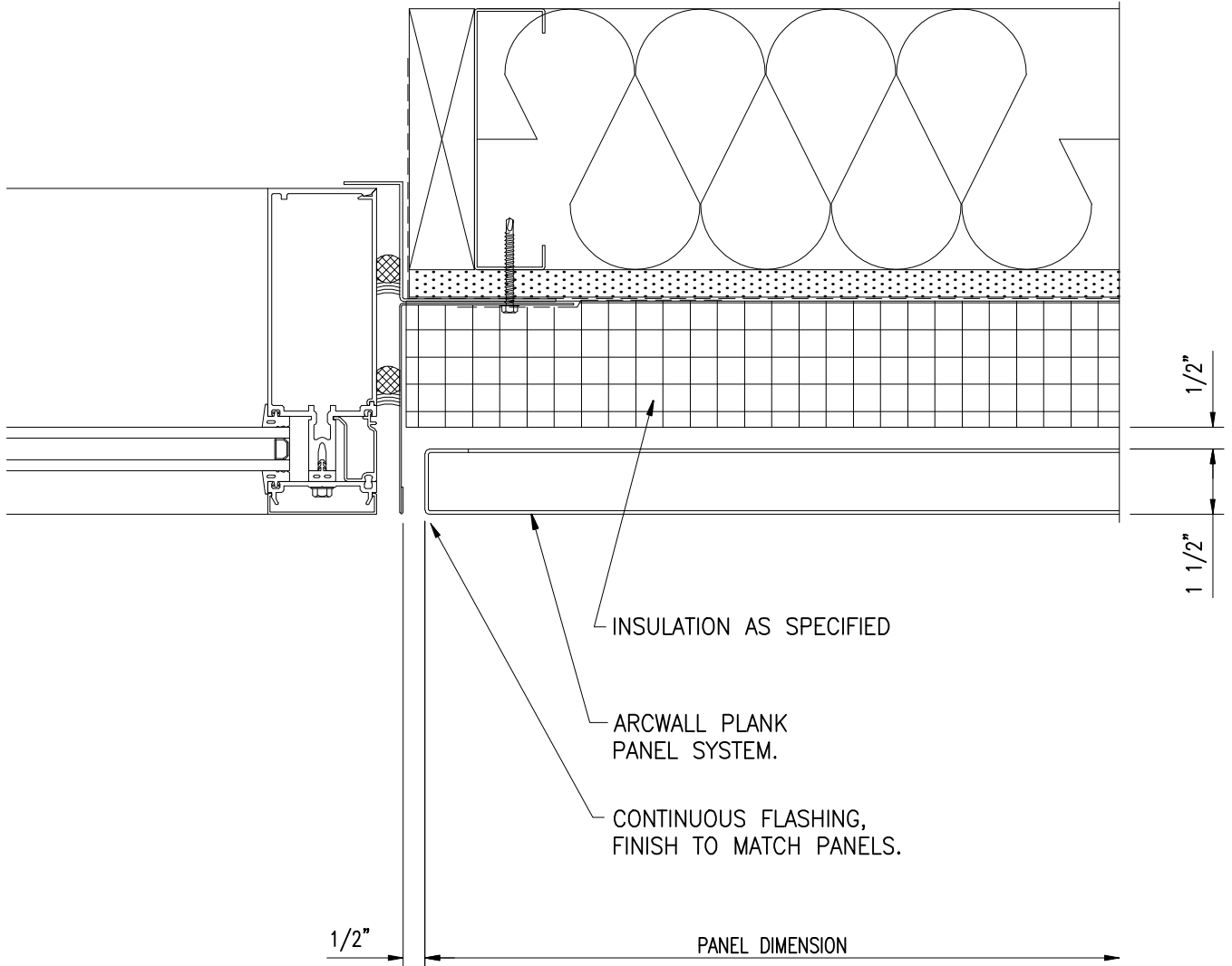

10A) PANEL JAMB DETAIL WITH INSULATION

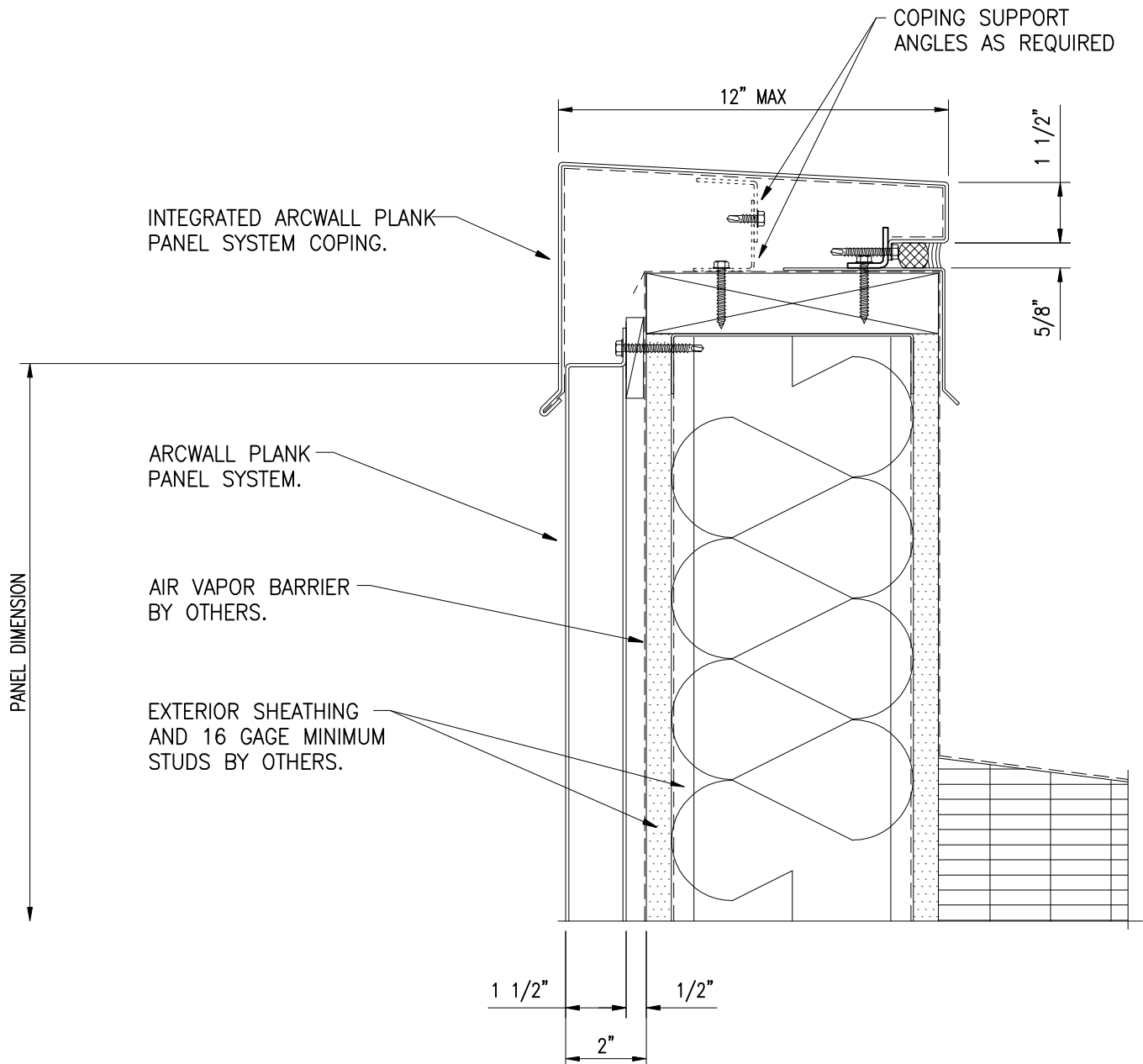
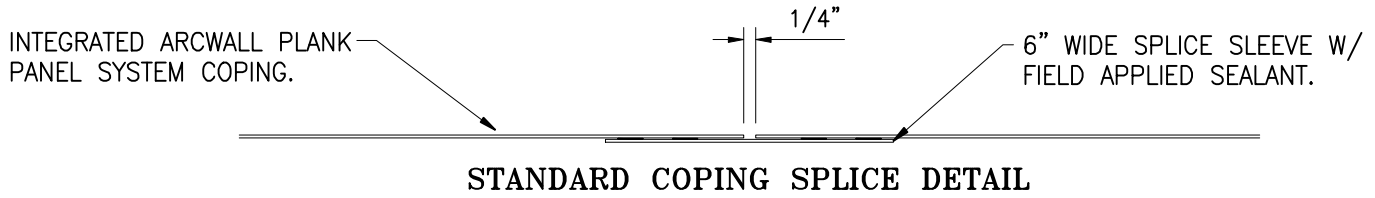

11) COPING DETAIL

ARCWALL INTERLOK PLANK
TYPICAL DETAILS
RAINSCREEN PANEL SYSTEM

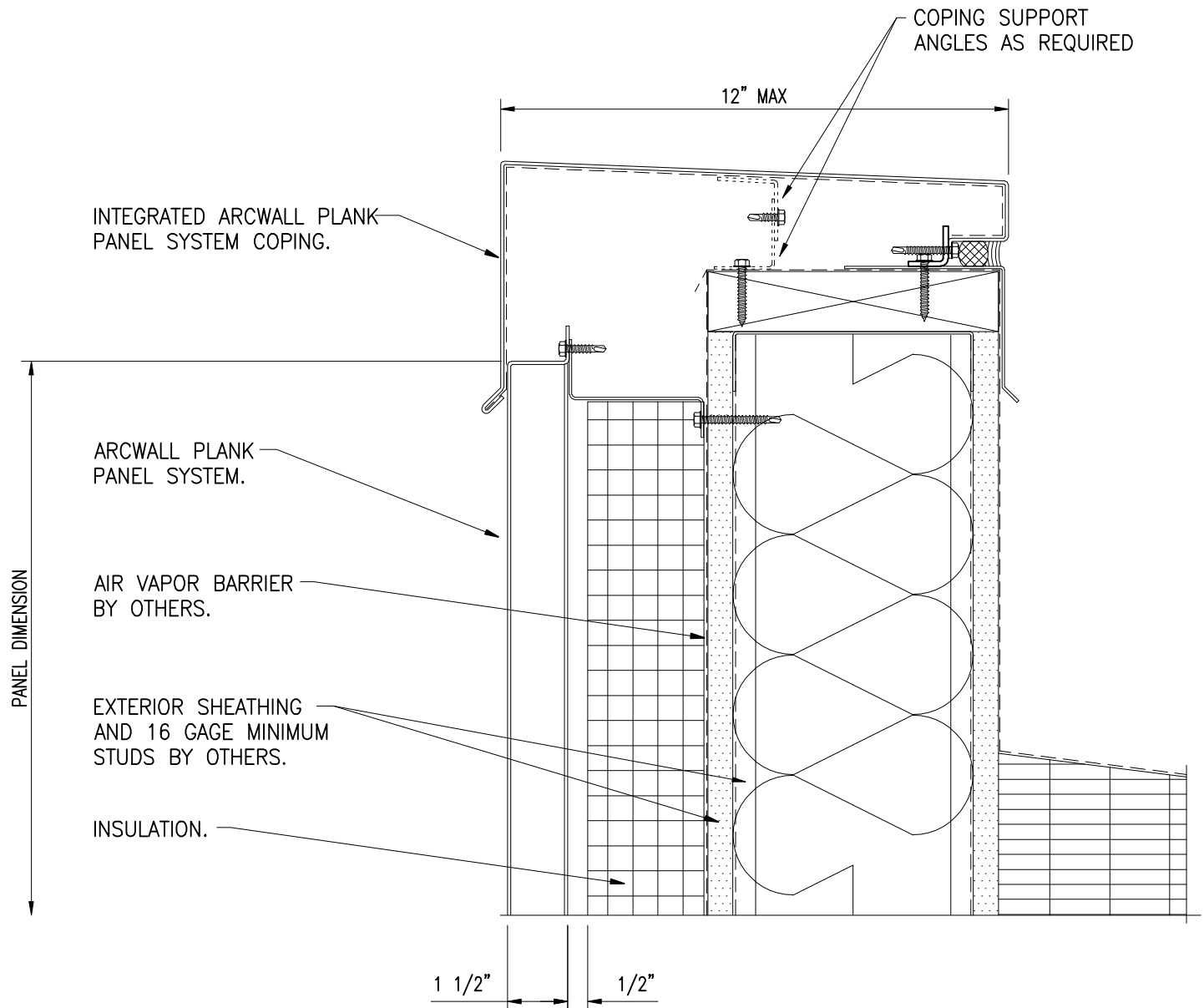
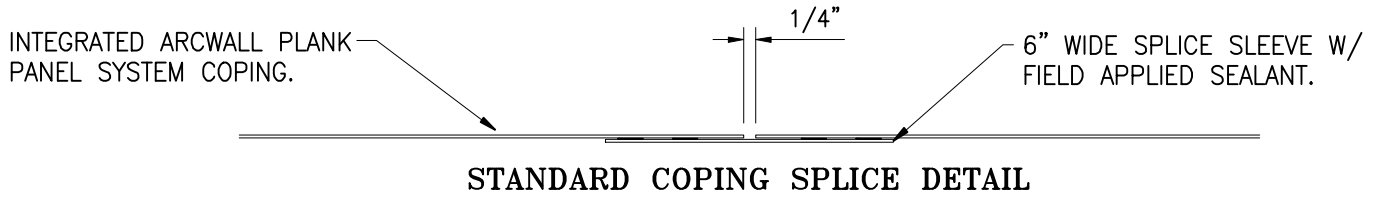

11A) COPING DETAIL WITH INSULATION

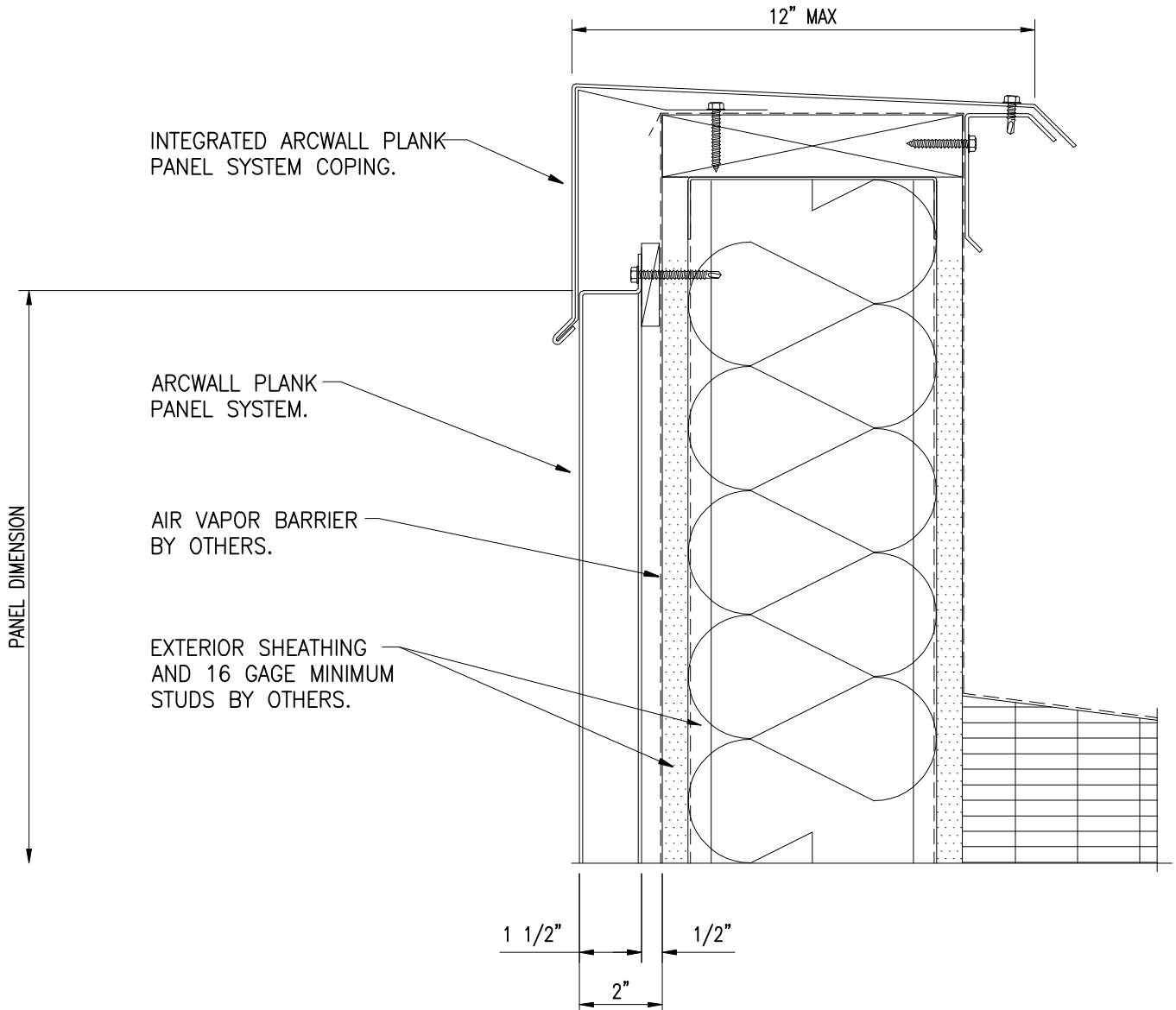

11B) COPING DETAIL OPTION

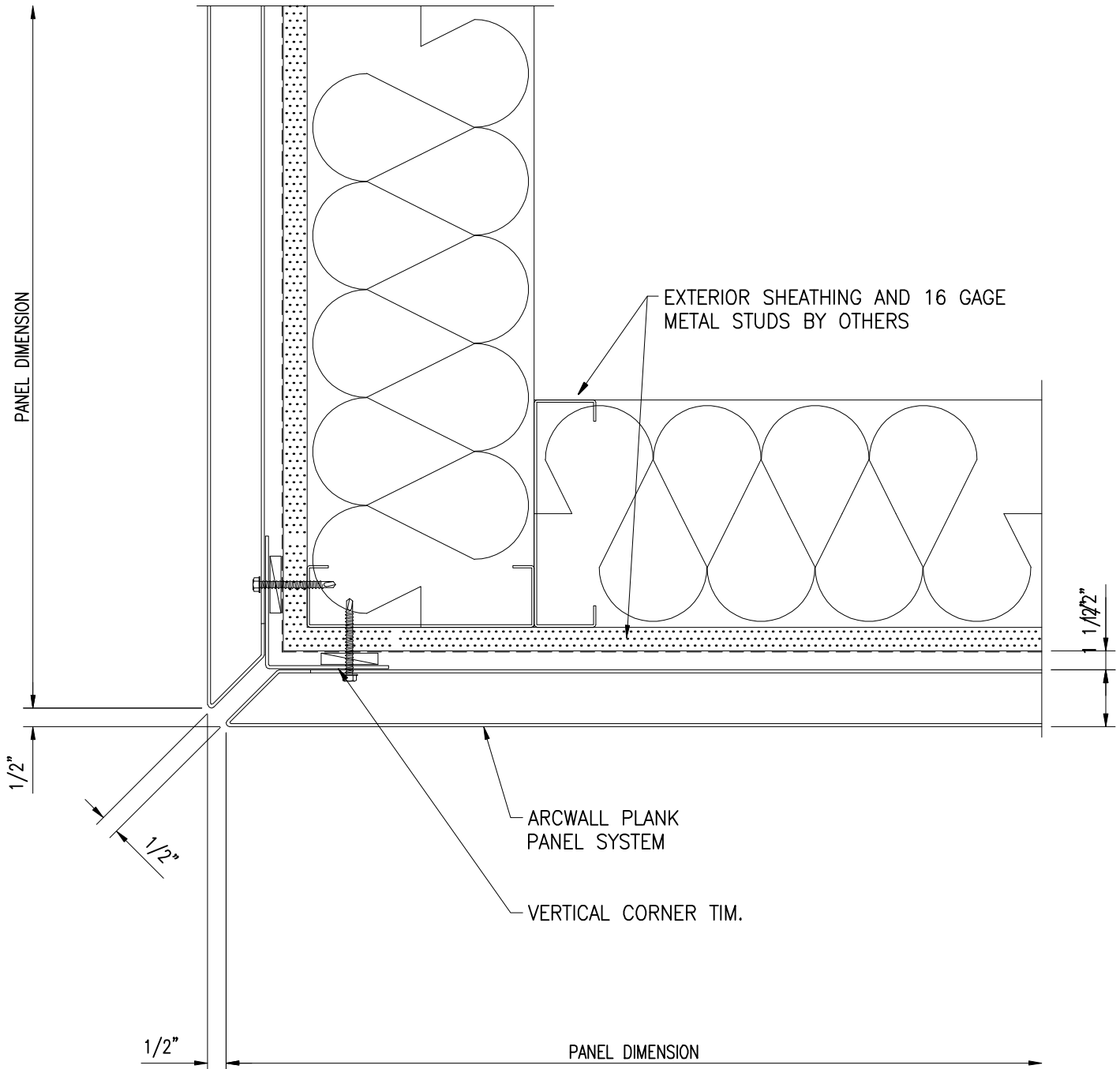

12) OUTSIDE CORNER DETAIL

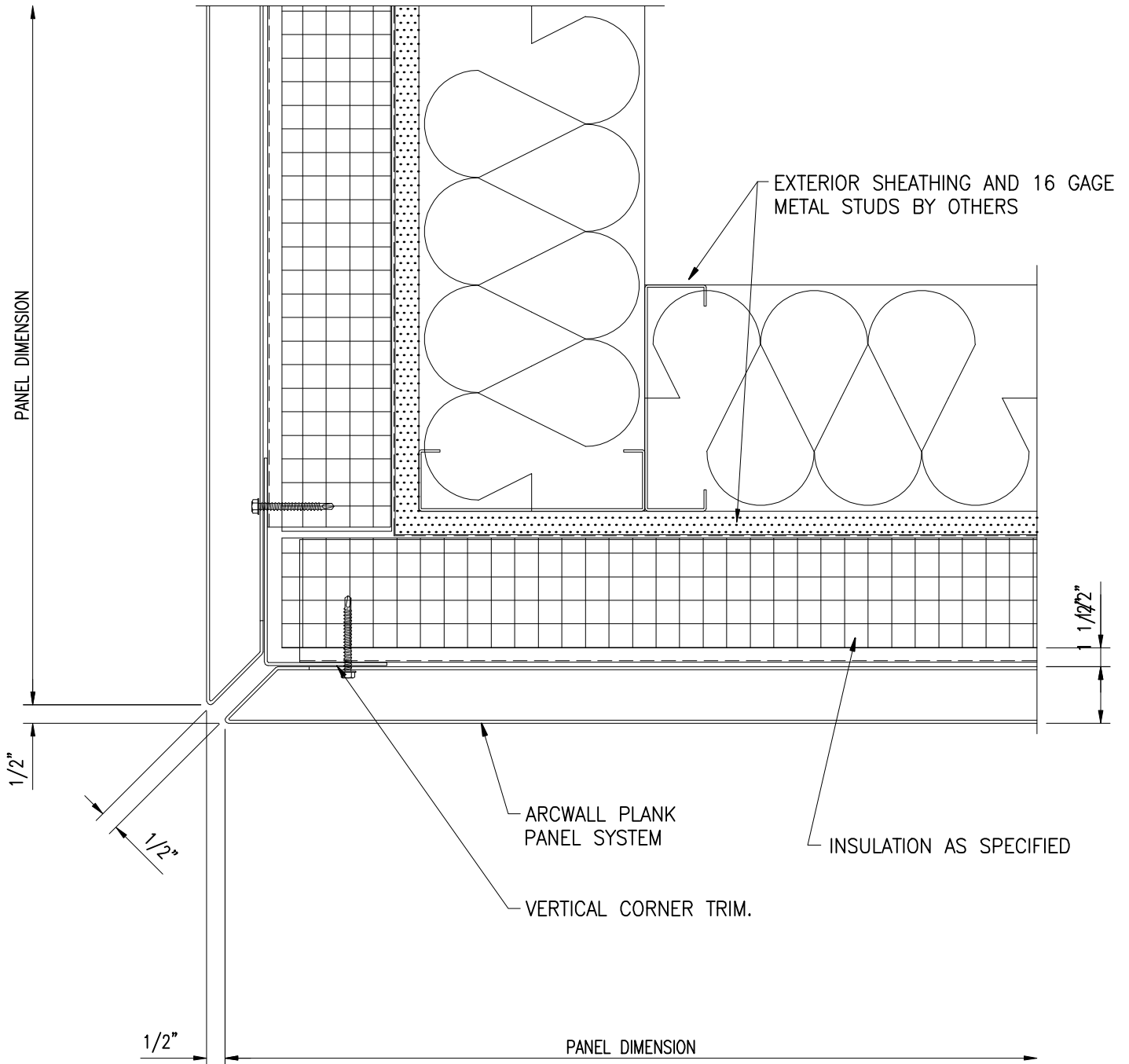

**12A) OUTSIDE CORNER DETAIL
WITH INSULATION**

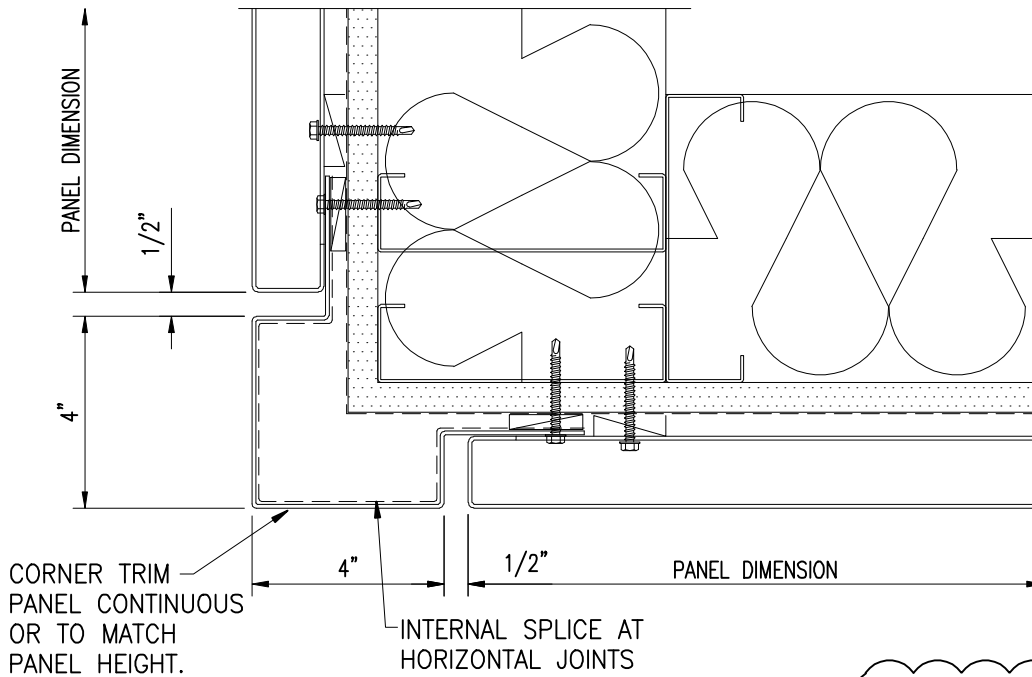

VERTICAL ORIENTED
CORNER TRIM PANEL

PLEASE NOTE METALLIC AND MICA
PAINT FINISHES WILL BE OREINTED
VERTICALLY ON CORENR TRIM
PANEL. PAINT FINISH WILL BE
ORIENTED HORIZONTALLY ON WALL
PANELS. PLEASE CONTACT SALES
FOR ADDITIONAL INFORMATION.

CORNER OPTIONS ALSO
AVAILABLE WITH INSULATION AND
FURRING.

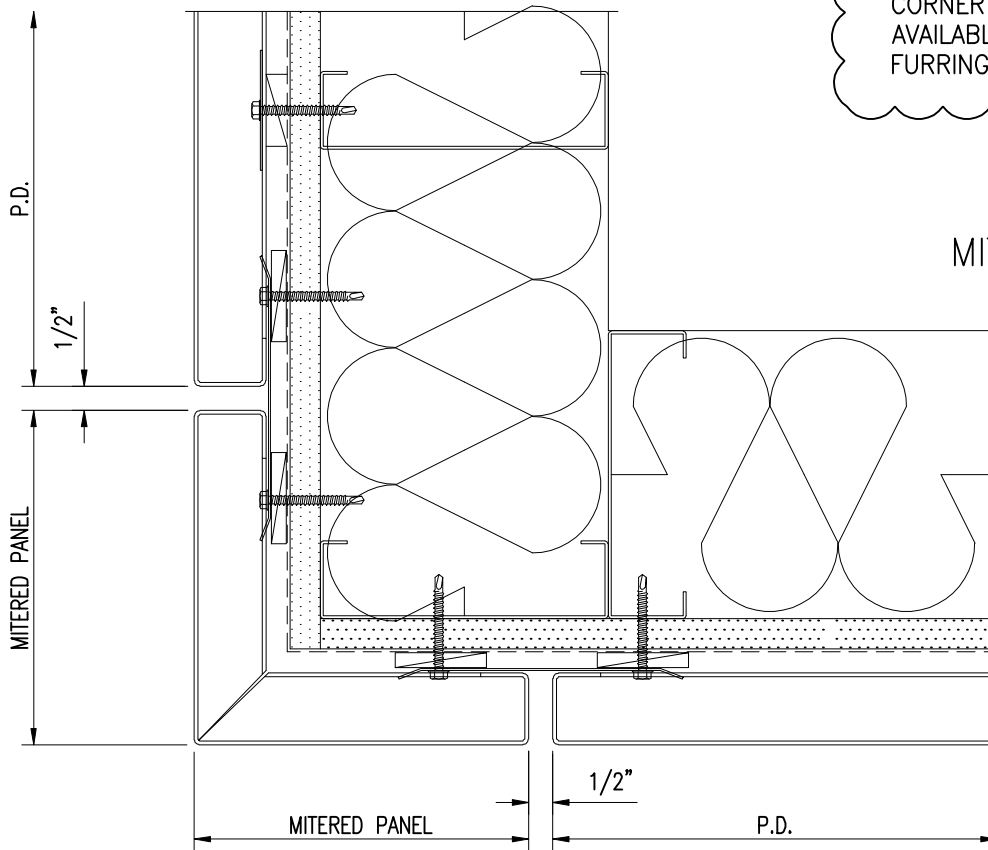

MITERED CORNER PANEL

METALLIC FLOP MAY
OCCUR WITH MICA AND
METALLIC FINISHES.
CONTACT METAL SALES
AND SERVICE FOR
ADDITIONAL INFORMATION.

PLEASE CONTACT SALES
FOR MITERED CORNER
PANEL SIZE LIMITATIONS.
24" MAX FOR ONE LEG.
6" MINIMUM.

12B) OPTIONAL OUTSIDE CORNER DETAILS

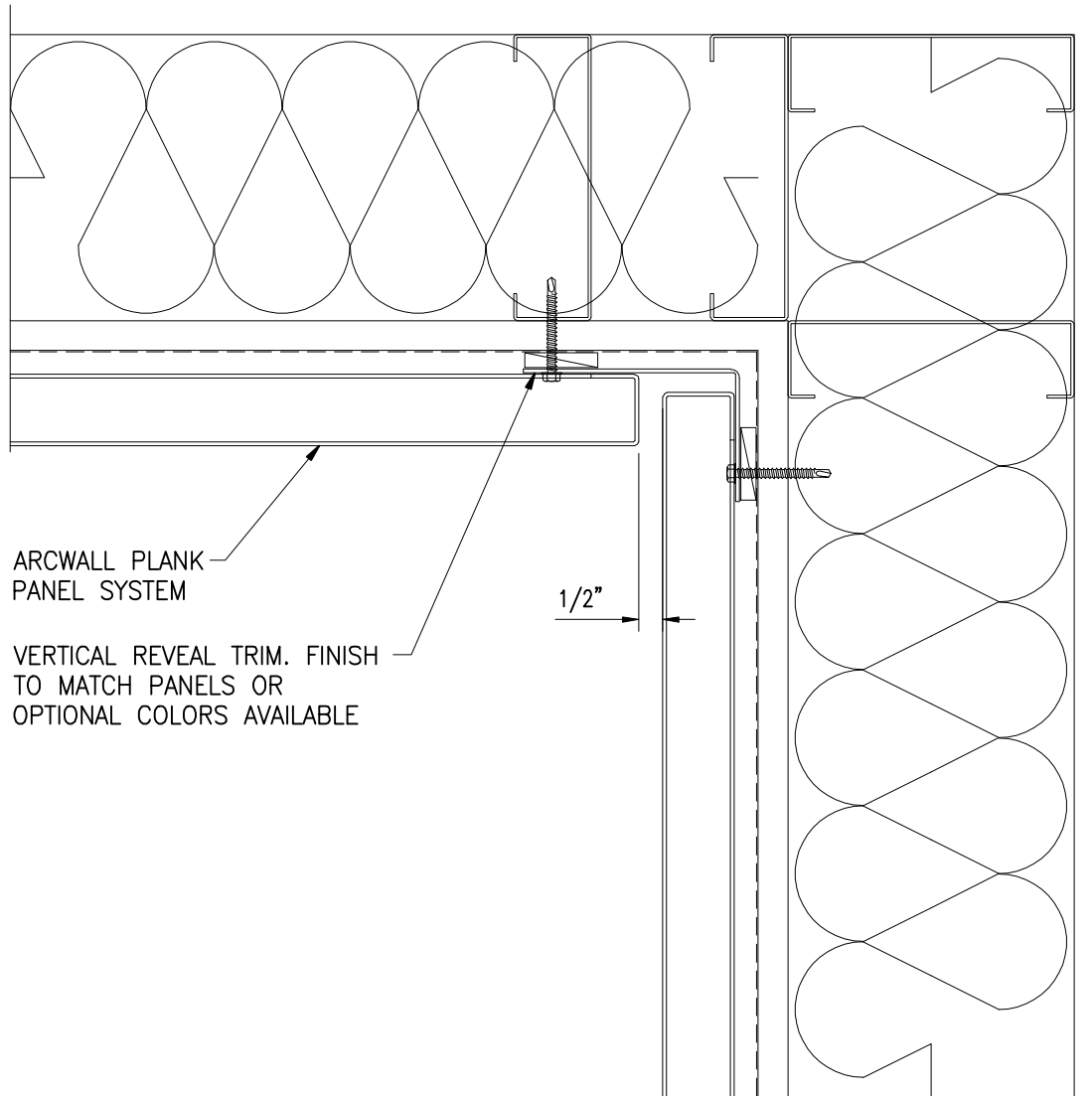

13) INSIDE CORNER DETAIL

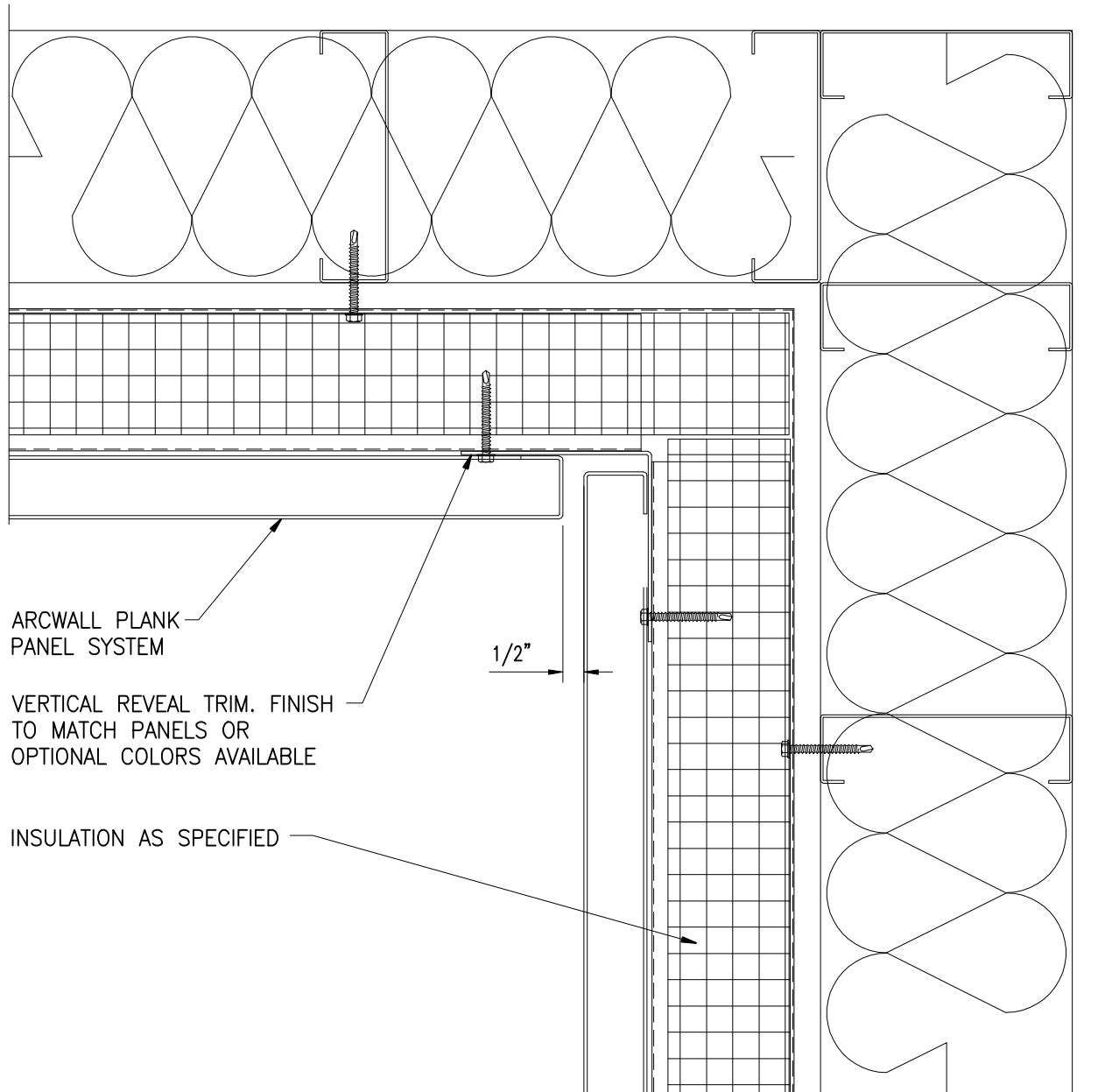

**13A) INSIDE CORNER DETAIL
WITH INSULATION**